

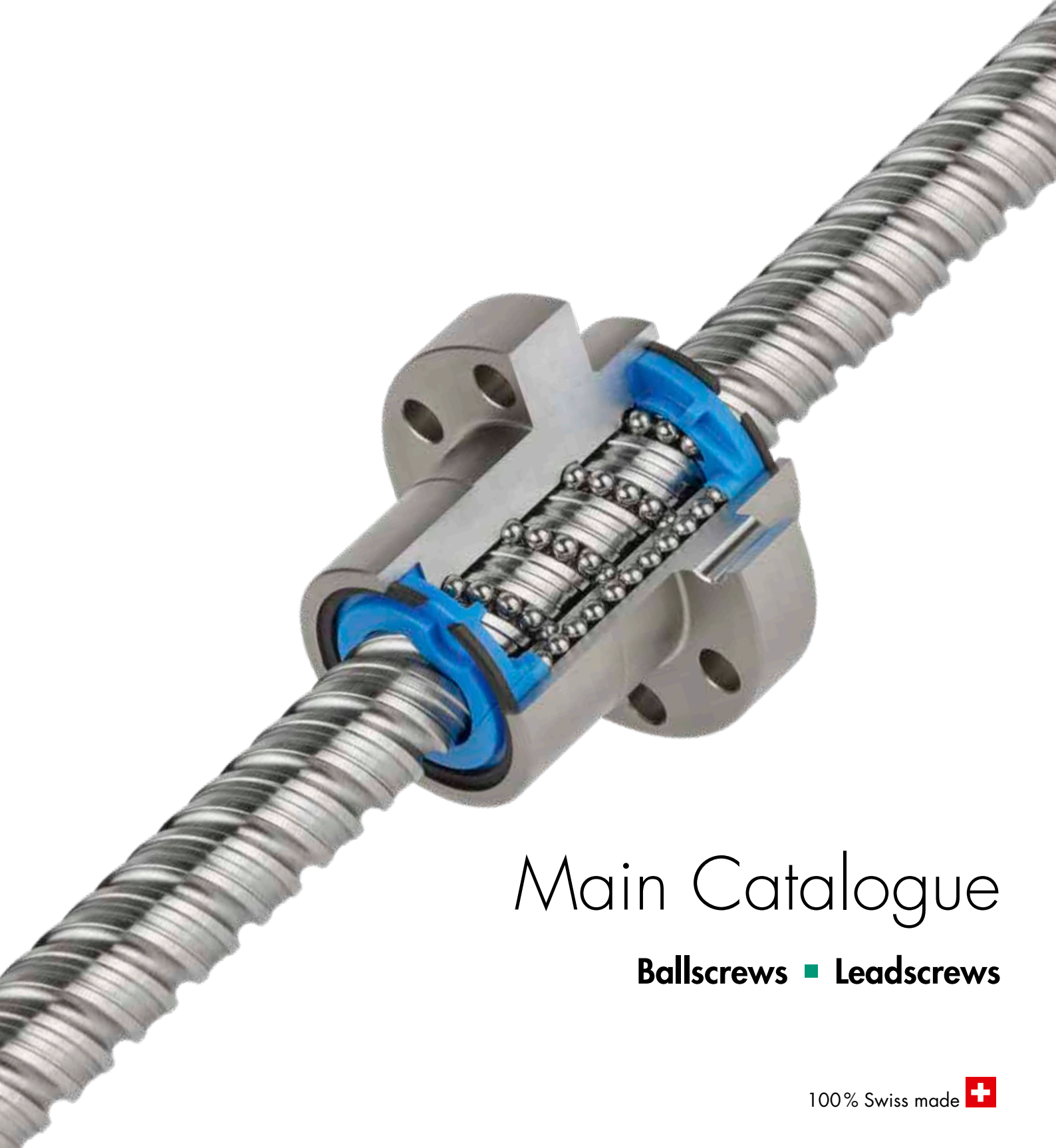



Eichenberger Gewinde



Main Catalogue

Ballscrews ■ Leadscrews

100% Swiss made 



Your partner for thread drive solutions – 100% Swiss-made

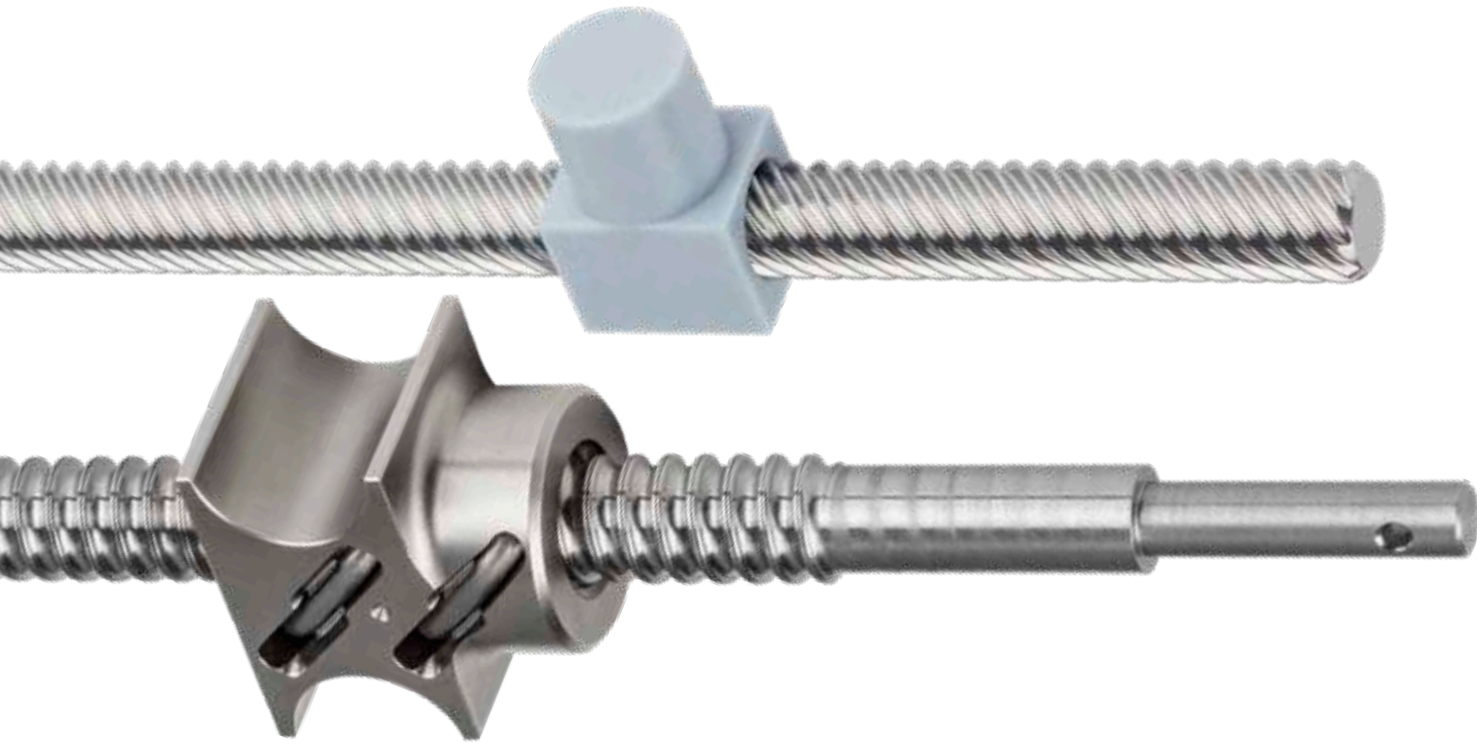

Cold-rolled thread drives for every requirement

Eichenberger Gewinde AG has been supplying customers all over the world with "100% Swiss-made" thread drives for more than 30 years.

Eichenberger thread drives are high-performance nut and shaft units that have been tried and tested in their millions in all sorts of applications in linear and drive technology. Cost-effective and with maximum reliability and service life, they are manufactured using the high-quality and extremely economical cold-rolling process and offer precise conversion of rotational movement into linear movement and vice versa.

We are constantly expanding our comprehensive standard range of ballscrews and leadscrews, providing you with efficient and economical solutions "off the shelf".

For complex projects with more advanced requirements, we can support you with expert advice at short notice during the development of individual drive solutions:

- customer-specific adjustments of Eichenberger standard thread drives
- unique, tailor-made special thread drives

Your tailor-made thread drive

Special requirements often demand tailor-made solutions. If our standard thread drives cannot fulfil your specs, we will offer a wide range of individualized options:

- application-specific nut shapes, including integrated additional features such as axles, mounting surfaces etc.
- individual thread profiles and customised ball sizes, e.g. for increased load ratings
- application-specific screw diameters and end machining
- special thread pitches
- customised number of ball circulations or number of carrying threads
- performance-optimised thread geometries
- special materials
- coating to improve sliding properties, to increase service life or as corrosion protection
- and much more.

Contact us with your revolutionary idea – we'll support you during development and provide YOUR tailor-made thread drive!

Content

Pages

Eichenberger thread drives

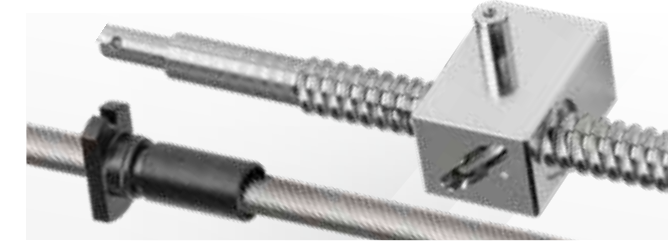

Range summary

- Individual tailor-made thread drives 4–5
- Standard range overview: Thread drive types and their characteristics 6–7

Eichenberger ballscrews



Carry ballscrews (KGT)

- Design features / Production / Handling 8–11
- Design fundamentals for ballscrews 12–15
- Order system / Dimension map 16–17
- Dimensional charts ø4 ... 40 mm 18–39

Eichenberger leadscrews



Speedy high-helix leadscrews (SGS)

- Design features / Production / Handling 40–43
- Design fundamentals for leadscrews 44–45
- Order system / Dimension map 46–47
- Dimensional charts ø4 ... 36 mm 48–57



Easy light leadscrews (EGS)

- Design features / Order system 58–59
- Dimensional chart ø20 mm / Applications 60–61



Rondo round-thread leadscrews (RGS)

- Design features / Order system 62–63
- Dimensional chart ø6 ... 16 mm 64–65

Thread rolling Advantageous thread production for everyone 66

Eichenberger Gewinde AG About us 67



Individual tailor-made thread drives

100% Swiss made

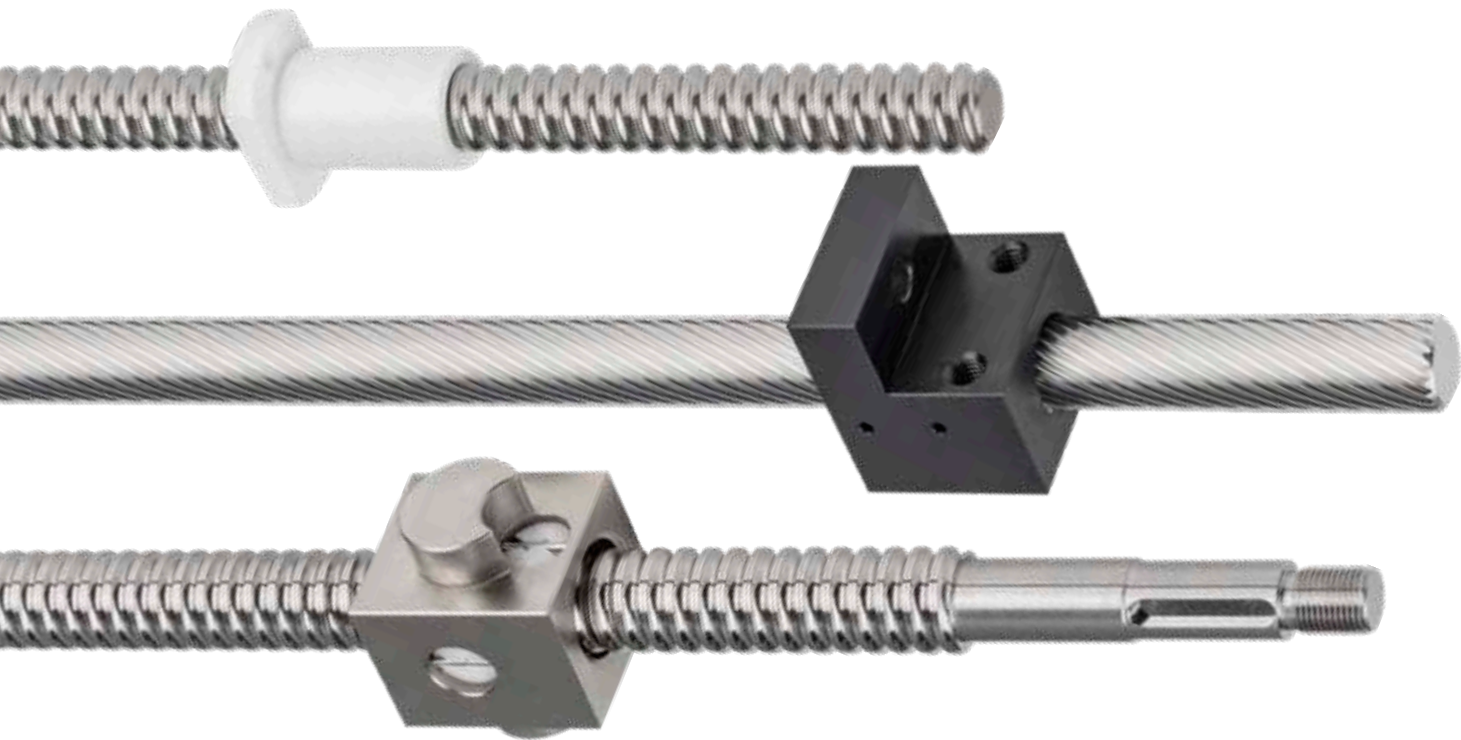

Your revolutionary idea – our tailor-made solutions

Any nut shape

Innovative solutions often require special, application-specific nut shapes – sometimes the nut even has to be integrated directly into a component. Or specific measurement requirements or performance parameters have to be complied with where standard thread drives simply don't suffice.

Thanks to maximum adaptability during development as well as manufacture, Eichenberger is your perfect partner for tailor-made thread drives in any shape and design.

Any kind of end machining

Our speciality is any kind of application-specific end machining – for your application, too.

Contact us with your revolutionary idea – we'll support you during development and provide YOUR tailor-made thread drive!



Examples of customer-specific and application-specific solutions

Carry 6x1

- Medical technology
- Special nut with application-specific flange



Carry 9.3x2

- Electronics industry (building electric motors)
- Customer-specific screw diameter, special nut, ball recirculation made of high-temperature technopolymer



Carry 8x2.5 made of corrosion-resistant steel

- Off-shore industry (towed array sonar)
- Special nut for use with a "cradle"
- Corrosion-resistant



Carry 16x5

- Off-shore industry (oil drilling)
- "Safety nut"



Carry 8x3

- Medical technology
- Special nut with direct linear slide connection



Carry 25x5

- Development and Prototype
- Hollow screw with extremely large, continuous bore hole

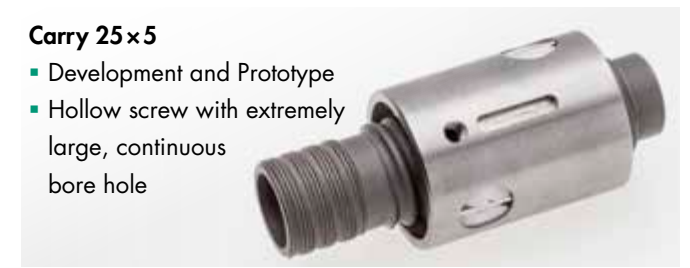

Carry 12x4

- Automation
- Special nut; screw and nut with coating to reduce sliding friction



Carry 10x2

- Electrically operated manual device
- Load rating increased based on customer-specific adjustment of tube type ball returns



Carry 10x2

- Medical technology; large-scale production
- Nut polished on the outside, featuring adhesive grooves



Carry 16x7

- Motor racing
- Special pitch
- Special nut



Speedy 4/10

- Injected two-part technopolymer nut ready for preloading by the customer



Speedy 26/60

- Graphics industry
- Stop adjustment

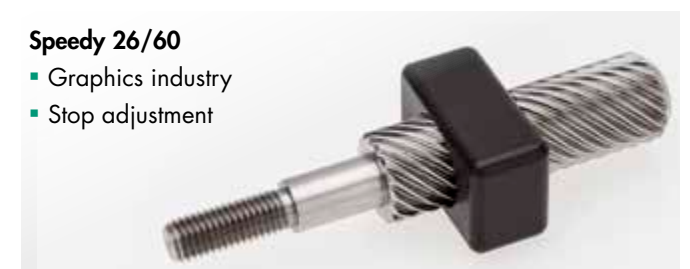



Standard range overview

100% Swiss made 



Cold-rolled precision

The manufacturing core competency of Eichenberger Gewinde AG is thread rolling. That is why the thread profiles of Eichenberger screws are exclusively made using this highly precise process.

Thread rolling describes the cold-forming process of the surface of round components. A thread is created by deforming a part between two rotating rolling tools with radial dynamic force application. The rolling tool profiles penetrate the surface of the part. So when the material is cold, it is pressed into the base of the thread rolling tool and rolled to the nominal dimensions.

Advantages of thread rolling:

- significant increase in strength based on cold-forming
- very good roughness values on the edges of the thread and in the base radius
- reduced notch-sensitivity
- grain orientation is not interrupted as in machined threads
- high dimensional accuracy
- efficient and quick production
- particularly cost-effective for large quantities



Even though all Eichenberger thread drives are made in accordance with the thread rolling process, the two construction series of the Eichenberger standard range,

- ball screws (recirculating ball screws in accordance with the principle of ball bearings) and
- lead screws (thread drives with nut and screw thread edges that slide onto each other),

have very different performance characteristics, which are demonstrated in the overview.

Thread drive types and their characteristics

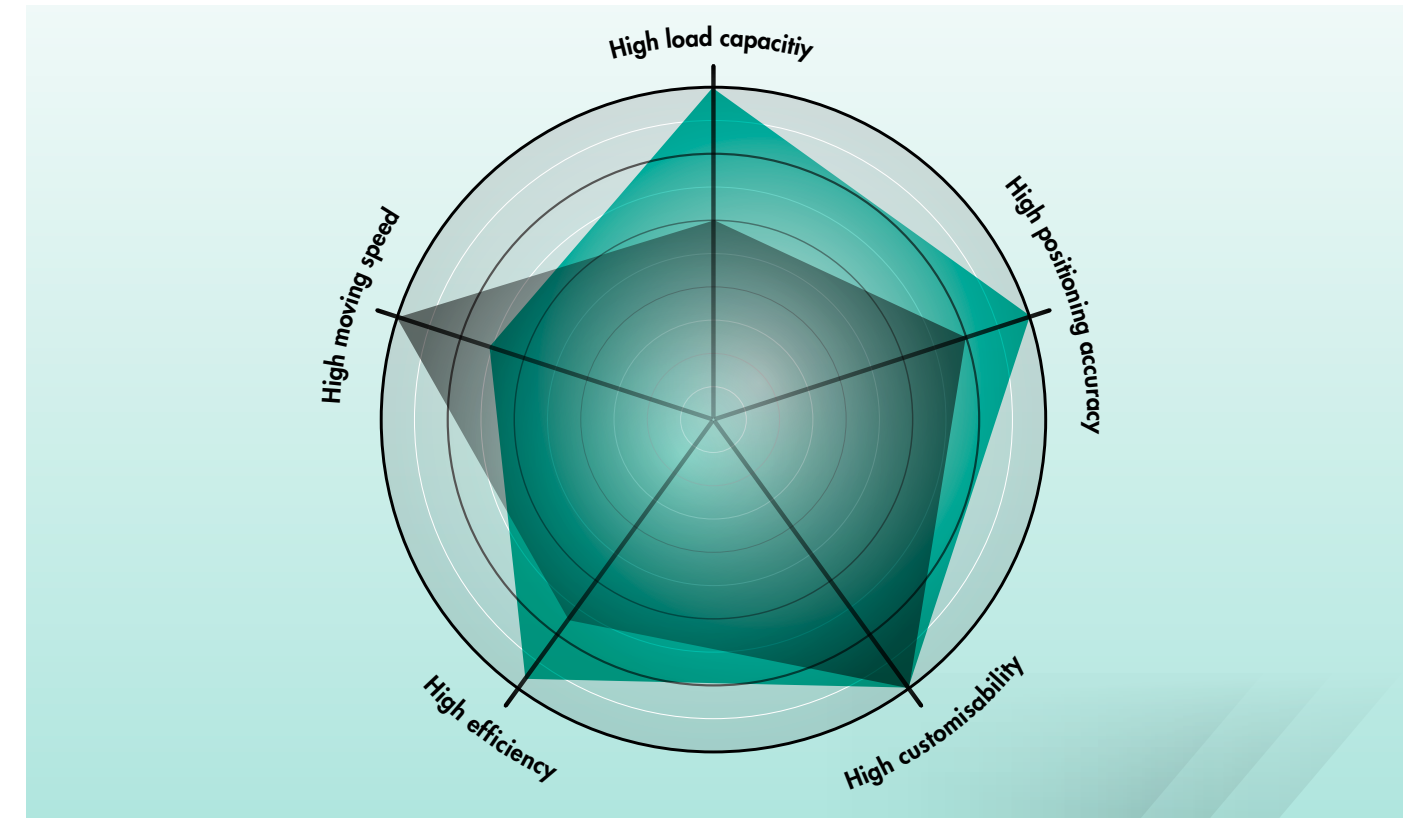

 Ballscrews

Eichenberger ballscrews are characterised by:

- high load ratings, and are therefore suitable for high static and dynamic loads
 - medium to high travelling speeds thanks to over-square pitches ($p > d$)
 - excellent efficiency ($\eta > 0.9$), therefore:
 - low drive power required
 - low energy consumption
 - low self-heating
 - low-friction operation
 - no stick-slip effect
 - high accuracy for positioning and repetition
 - high reliability and long service life with minimum need for maintenance
 - wipers possible
- **Carry** ballscrews pages 8–39

 Leadscrews

Eichenberger leadscrews are characterised by:

- small to medium load ratings, therefore suitable for low to medium loads
- very high travelling speeds, thanks to over-square pitches ($p \leq 6 \times d$)
- high efficiency ($\eta \sim 0.5 \dots 0.8$), thanks to the finest surface quality of the steel leadscrews and nuts made of high-performance technopolymer
- weight optimisation possible based on aluminium screws
- performance optimisation sometimes possible based on coating
- high reliability and long service life with marginal need for maintenance

Eichenberger's leadscrew range includes three types:

- **Speedy** high-helix leadscrews pages 40–57
- **Easy** light leadscrews pages 58–61
- **Rondo** round-thread leadscrews pages 62–65



Design features

Carry screws are made using the highly economical cold-rolling process, offering – at a significant price advantage – precision that has so far only been achieved with ground screws. Carry screws are combined with individual steel nuts which are produced in a unique, highly efficient process.

Carry ballscrews offer all the advantages that are characteristic of ballscrews, such as:

- high efficiency ($\eta > 0.9$), i.e.
 - low drive power
 - low self-heating
- high load ratings
- low-friction, stick-slip-free operation
- minimum wear, i.e. with consistent positioning precision, very good repeat accuracy is achieved
- high reliability and long service life

Load ratings C_{dyn} and C_{stat}

The dynamic and static load ratings of Eichenberger ballscrews are determined on commonly used and recognised DIN calculation bases.

According to our experience, higher values are usually achieved during practical applications.

Materials

- standard: steel
 - 1.3505 (100Cr6)
 - 1.1213 (Cf53)
- on request:
 - corrosion-resistant steel 1.4034 (X46Cr13)
 - other materials
- on request:
 - coating for corrosion protection

 The use of corrosion-resistant steel results in lower load ratings! Details on request.

Lead accuracy

- standard:
 - G9 $\hat{=}$ ≤ 0.1 mm/300 mm (in accordance with DIN 69051)
- on request:
 - G7 $\hat{=}$ ≤ 0.052 mm/300 mm
 - G5 $\hat{=}$ ≤ 0.023 mm/300 mm

Carry ballscrews – design features

Nut types (shapes)



- Nut with mounting thread
Type FG...
- cost-effective standard nut
 - outer diameter turned
 - with pin wrench hole



- Cylindrical nut
Type ZY...
- outer diameter ground
 - with keyway



- Flange nut
Type FB... / FA...
- mounting section and flange ground (Type FB...)
 - drilling pattern 1/2/3 following DIN 69051
 - flange type C on request

If required, any application-specific nut shapes can be manufactured.

Contact us with your revolutionary idea – we'll provide YOUR tailor-made ballscrew!

Reduced backlash

Reduced backlash up to ≤ 0.01 mm is possible, if required (only for paired screw and nut units or those that have been mounted).

Efficiency

Efficiency η for Carry ballscrews is more than 0.9
> also see calculations and diagram, page 14

Ball return systems



- End cap ball returns
Type ...E / ...F 
- also for over-square pitches ($p \geq d_o$)
 - wipers firmly integrated into end caps
 - made of high-performance technopolymer
 - cost-effective



- Tube ball return, fully integrated into nut body
Type ...R 
- for heavy loads
 - can also be used in high temperatures
 - space-saving in length



- Single-thread ball return
Type ...I 
- space-saving in diameter
 - made of high-performance technopolymer
 - other materials (e.g. brass) on request

Operational temperatures

During normal use: -20 to $+80$ °C.
Different operational temperatures after consultation.

Wipers

Depending on the type, technopolymer wipers (K) or brush wipers (B) can be mounted. Felt rings (F) on request (for lifetime lubrication).



Production lengths

In general, Eichenberger screws are produced as threaded rods with a length of 3 m.

Any kind of end machining

Ballscrew ends are without any machining cut by grinding (standard).

Upon request, a so-called standard screw end journal with three turned bearing seats is available. Dimensions are as per customer specifications. Note also the links to the CAD data at www.gewinde.ch

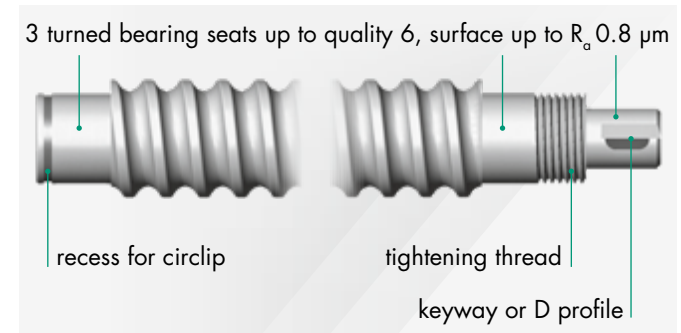

Screws may also be ordered with softened ends for subsequent finishing by the customer.

Our speciality is any application-specific end machining: Tell us your requirements, and we'll provide YOUR tailor-made screw!

In each instance, a detailed drawing would be necessary.

Radial loads and torque

Radial loads or torque brought to bear upon the nut result in overload of individual contact surfaces, thus seriously affecting the service life of the ballscrew assembly. Therefore it is important to properly mount the screw and to comply with all relevant form and positional tolerances.

Handling

Ballscrews are precision parts and must be protected from shock, dirt or moisture when transported or stored. Please do not unpack until ready for use.

Please check for cleanness when mounting the ballscrew. Dirt or foreign matter on the ball race – especially inside the nut – may cause increased wear and premature failure.

Lubrication

The usual specifications for lubricating ball bearings also apply to ballscrews. However, lubrication applied only once but intended to last a lifetime is not sufficient in most cases. Regular lubrication is required to extend the service life of the ballscrew.

⚠ When shipped, screws simply have a protective film. Before mounting or operating the ballscrew, units must be lubricated with the proper lubricant (through the lube hole for nuts with wipers; directly onto the screw for nuts without wipers).

Recommended all-purpose lubricant:

- Klüber Microlube GBU Y 131

When using another lubricant, please verify compatibility with anticorrosion agent; otherwise rinse ballscrew unit prior to lubrication.

Do not use grease containing graphite or MoS!

Surface coatings

... possible on request:

- generally to reduce sliding friction
- if lubrication is not possible (e.g. in the food industry)
- as corrosion protection > also see Materials, page 8

Assembling of ballscrew units

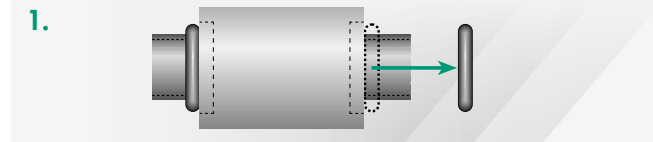

Remove transport lock (O-ring) on one side.

⚠ Please keep sleeve and nut in horizontal position. Otherwise, the nut may slide from the sleeve and balls may fall out of the ball race.

In the event such incident does occur, balls must be properly re-inserted to prevent damage to or blockage of the ballscrew. If in doubt, please contact Eichenberger Gewinde AG.

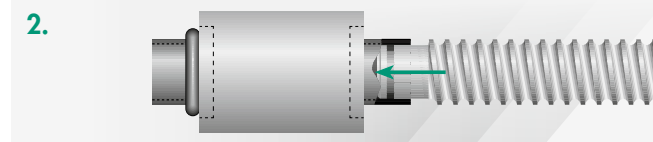

Insert screw end into mounting sleeve.

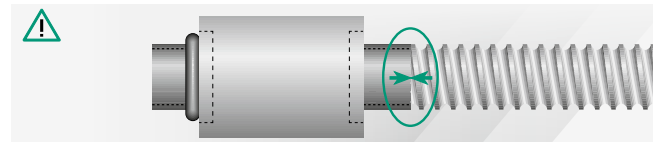

Operator must be able to advance sleeve up to the thread intake. Otherwise, balls may fall out of the ball race and damage or block the unit.

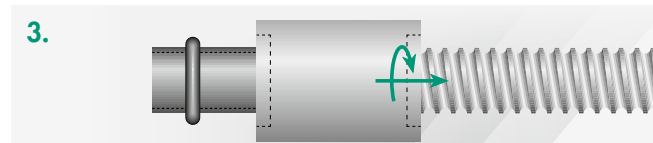

Gently turn nut onto the screw.

Please consult lubrication recommendation opposite before mounting or operating ballscrews.

Design fundamentals

The following are the relevant calculations which underlie screw design and safe operation.

For detailed information on ballscrew design, please refer to DIN 69051.

«Suitability test» rotational speed characteristics

When selecting a ballscrew it is important to first ensure that the correct nut design for the ball return system required to support the maximum rotational speed demanded by the application is used (independent of the screw length).



The maximum rotational speed is based on the system's rotational speed characteristics and the outer screw diameter:

$$n_{\max} = \frac{\text{rotational speed characteristic}}{d_1} \quad [\text{min}^{-1}]$$

n_{\max} = maximum rotational speed [min⁻¹]

d_1 = outer screw diameter [mm]

Rotational speed characteristic [-] for:

- single-thread ball return: 60 000
(Carry type ...I )
- tube ball return: 80 000
(Carry type ...R )
- end cap ball return: 80 000
(Carry type ...E/...F )

Calculations at dynamic load

Critical rotational speed n_{per}

Permissible rotational speeds must differ substantially from the screw's own frequency.

$$n_{\text{per}} = K_D \cdot 10^6 \cdot \frac{d_2}{l_a^2} \cdot S_n \quad [\text{min}^{-1}]$$

n_{per} = permissible rotational speed [min⁻¹]

K_D = characteristic constant [-]

as a function of bearing configuration > see below

d_2 = core screw diameter [mm]

l_a = bearing distances [mm] > see below

(always include maximum allowable l_a in calculation!)

S_n = safety factor [-], usually $S_n = 0.5 \dots 0.8$

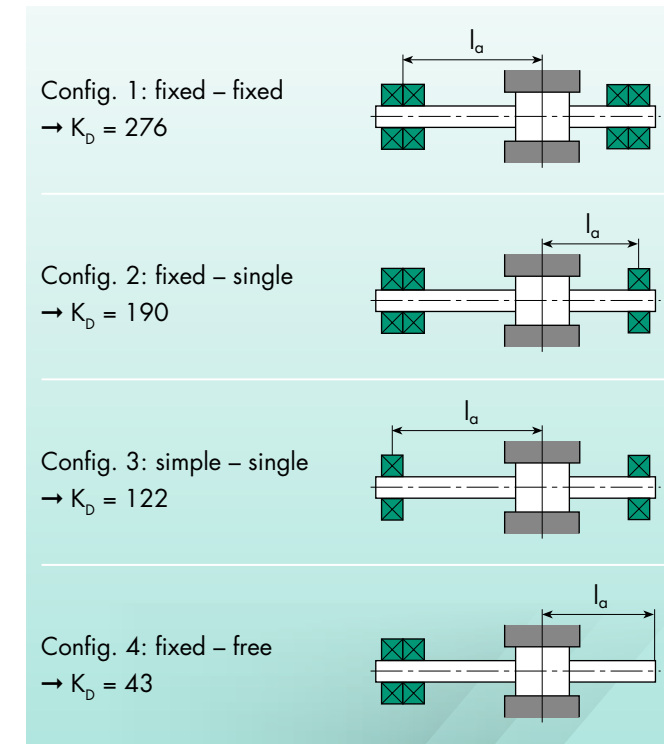

Nominal service life L_{10} or L_h

$$L_{10} = \left(\frac{C_{\text{dyn}}}{F_m} \right)^3 \cdot 10^6 \quad [\text{R}]$$

$$L_h = \frac{L_{10}}{n_m \cdot 60} \quad [\text{h}]$$

L_{10} = service life in revolutions [R]

L_h = service life in hours [h]

C_{dyn} = dynamic load rate [N]

F_m = average axial load [N]

$F_{1\dots n}$ = load per cycle unit [N]

n_m = average rotational speed [min⁻¹]

$n_{1\dots n}$ = rotational speed per cycle unit [min⁻¹]

$q_{1\dots n}$ = cycles [%]

100 = $\sum q$ (sum of cycles $q_{1\dots n}$) [%]

Average axial load F_m

at constant rotational speed n_{const} and dynamic load C_{dyn}

$$F_m = \sqrt[3]{F_1^3 \frac{q_1}{100} + F_2^3 \frac{q_2}{100} + \dots + F_n^3 \frac{q_n}{100}} \quad [\text{N}]$$

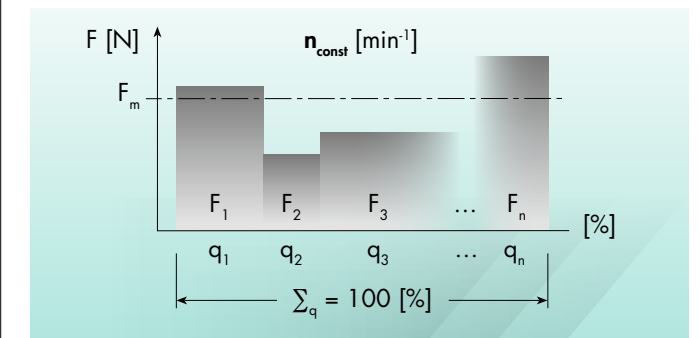

$$\rightarrow L_{10} = \left(\frac{C_{\text{dyn}}}{F_m} \right)^3 \cdot 10^6 \quad [\text{R}]$$

$$\rightarrow L_h = \frac{L_{10}}{n_{\text{const}} \cdot 60} \quad [\text{h}]$$

Calculations at dynamic load (continued)

Average rotational speed n_m
at constant load F_{const} and variable rotational speeds $n_{1...n}$

$$n_m = n_1 \frac{q_1}{100} + n_2 \frac{q_2}{100} + \dots + n_n \frac{q_n}{100} \text{ [min}^{-1}\text{]}$$

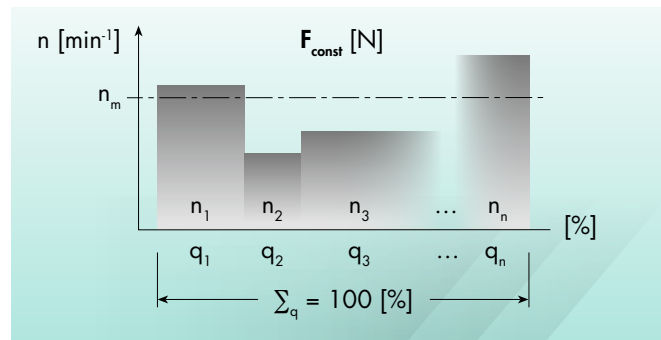

$$\rightarrow L_{10} = \left(\frac{C_{dyn}}{F_{konst}} \right)^3 \cdot 10^6 \text{ [R]}$$

$$\rightarrow L_h = \frac{L_{10}}{n_m \cdot 60} \text{ [h]}$$

Average axial load F_m
at constant rotational speeds $n_{1...n}$ and dynamic load C_{dyn}

$$F_m = \sqrt[3]{\frac{F_1^3 \cdot n_1 \cdot \frac{q_1}{100} + F_2^3 \cdot n_2 \cdot \frac{q_2}{100} + \dots + F_n^3 \cdot n_n \cdot \frac{q_n}{100}}{n_m}} \text{ [N]}$$

$$n_m = n_1 \frac{q_1}{100} + n_2 \frac{q_2}{100} + \dots + n_n \frac{q_n}{100} \text{ [min}^{-1}\text{]}$$

$$\rightarrow L_{10} = \left(\frac{C_{dyn}}{F_m} \right)^3 \cdot 10^6 \text{ [R]}$$

$$\rightarrow L_h = \frac{L_{10}}{n_m \cdot 60} \text{ [h]}$$

Efficiency η (theoretical)
depends upon the type of power transmission

- Case 1: torque \rightarrow linear movement

$$\eta \approx \frac{\tan \alpha}{\tan (\alpha + \rho)} \text{ [-]}$$

- Case 2: axial force \rightarrow torque

$$\eta' \approx \frac{\tan (\alpha - \rho)}{\tan \alpha} \text{ [-]}$$

whereby

$$\tan \alpha \approx \frac{p}{d_o \cdot \pi} \text{ [-]}$$

- η = efficiency [%]
- η' = corrected efficiency [%]
- p = pitch [mm]
- d_o = nominal screw diameter [mm]
- ρ = angle of friction [°] $\rightarrow \rho = 0.30 \dots 0.60^\circ$

Efficiency η_p (practical)
The efficiency η for Carry ballscrews is better than 0.9

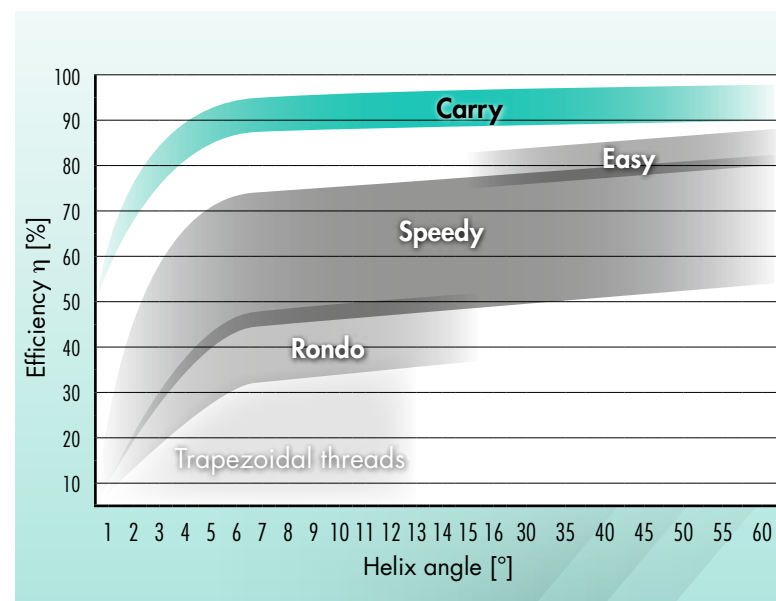

Driving torque M
depends upon the type of power transmission

- Case 1: torque \rightarrow linear movement

$$M_o = \frac{F_o \cdot p}{2000 \cdot \pi \cdot \eta} \text{ [Nm]}$$

- Case 2: axial force \rightarrow torque

$$M_e = \frac{F_o \cdot p \cdot \eta'}{2000 \cdot \pi} \text{ [Nm]}$$

- M_o = input torque [Nm], case 1
- M_e = output torque [Nm], case 2
- F_o = axial force [N]
- p = pitch [mm]
- η = efficiency [%]
- η' = corrected efficiency [%]

Input performance P

$$P = \frac{M_o \cdot n}{9550} \text{ [kW]}$$

- P = input performance [kW]
- n = rotational speed [min⁻¹]

A safety margin of 20% is recommended when selecting drives.

Calculations at static load

Permissible maximum load F_{per}

$$F_{per} = \frac{C_{stat}}{f_s} \text{ [N]}$$

- C_{stat} = static load rate [N]
- f_s = operating coefficient
 - \rightarrow normal operation: 1 ... 2 [-]
 - \rightarrow shock load: 2 ... 3 [-]

Permissible buckling force F_B

$$F_B = \frac{K_B}{S_B} \cdot \frac{d_2^4}{l_a^2} \cdot 10^3 \text{ [N]}$$

- K_B = characteristic constant of load [-]
depends on design \rightarrow see below
- d_2 = core screw diameter [mm]
- S_B = buckling safety factor [-] \rightarrow usually $S_B = 2 \dots 4$
- l_a = force-transferring screw length [mm]

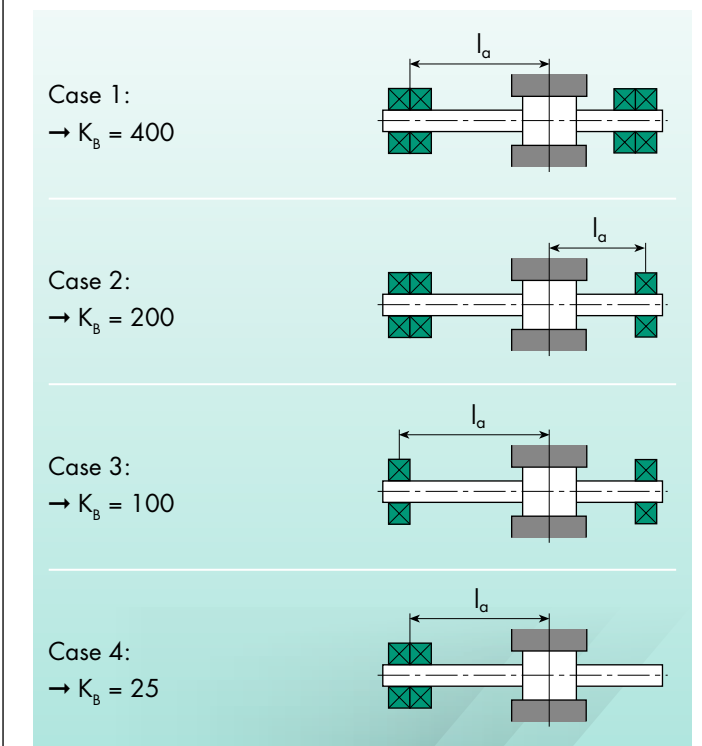



Order system – Carry ballscrews

Example for complete Carry ballscrew KGT 16x5 FGR RH 1 S 350 G7 A E M

Type of thread drive
KGT = Carry ballscrew

Nominal size (d₀ × p) [mm]

Nut type:

- **Shape** for nut only
ZY = cylindrical nut type ZY...
FG = nut with mounting thread type FG...
FB = flange nut type FB...
FA = flange nut type FA...
MS = special design according to drawing
- **Ball return system** (assignment to nut shapes acc. dimensional charts) for nut only
I = single-thread ball return type ...I
R = tube ball return type ...R
E = end cap ball return type ...E
F = end cap ball return type ...F
- Right-hand / left-hand thread** for nut only
RH = right-hand thread (standard)
LH = left-hand thread (availability see dimensional charts)
- Number of ball circulations (i)** for nut only
1 = 1 ball circulation
2 = 2 ball circulations
3 = 3 ball circulations
4 = 4 ball circulations
- Wipers (SA)** for nut only
S = with wipers (technopolymer or brush)
N = without wipers
- Ballscrew overall length [mm]** for screw only
- Lead accuracy (class)** for screw only
G9 = ≤0.1 mm/300 mm (standard)
G7 = ≤0.052 mm/300 mm (on request)
G5 = ≤0.023 mm/300 mm (on request)
- Backlash (T_{max})** for screw only
A = standard backlash (see dimensional charts)
R = reduced backlash upon specification
- Screw end machining** for screw only
O = no end machining (cut by grinding, hardened ends)
E = end machining according to drawing
- Assembly**
G = screw and nut separate
M = screw and nut assembled according to drawing/specified orientation

Example for screw only KGT 16x5 RH 350 G7 O G

Example for nut only KGT 16x5 FGR RH 1 S A G

Dimension map – Carry standard range

d ₀ × p [mm]	Nominal diameter d ₀ [mm]													
	4	5	6	8	10	12	12.7	14	15	16	20	25	32	40
1	■		■	■										
1.5				■										
2		■	■	■	■	■		■		■	■			
2.5				■										
3		■		■	■	■								
4					■	■		■						
5				■		■				■	■	■	■	■
6			■											
8				■										
10					■	■				■	■	■	■	
12				■		■								
12.7							■							
15													■	
16										■				
20									■		■			■
25												■		
25.4							■							
30												■		
32													■	
40														■
50										■				
Register	σ 4/5/6			σ 8	σ 10	σ 12	σ 12.7	σ 14	σ 15/16		σ 20	σ 25	σ 32	σ 40
Pages	18/19			20/21	22/23	24/25	26/27	28/29	30/31		32/33	34/35	36/37	38/39



ø 4/5/6

Cylindrical nut

ZY...

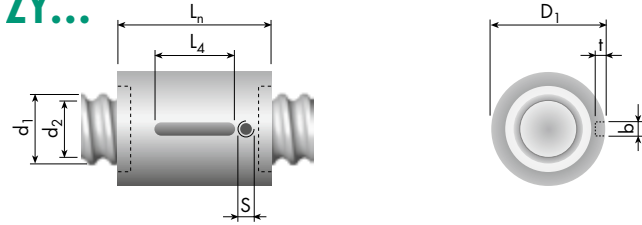

Nut with mounting thread

FG...

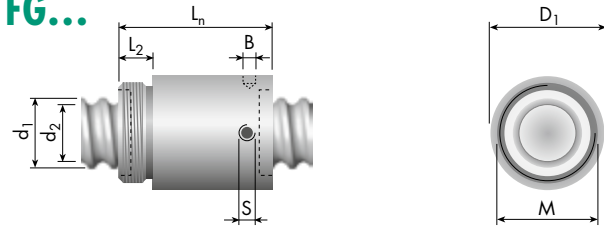

Flange nut

FB...

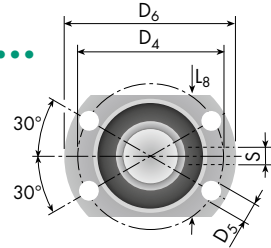

FA...

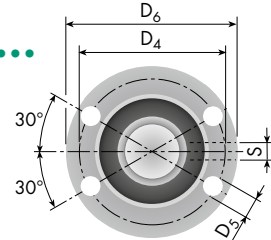

Nominal size d ₀ × p [mm]	Ball return Type	Relative cost	Right-/ left-hand thread	Dimensions [mm]																				Load rates [N]		Nominal size d ₀ × p [mm]				
				Screw										Nut										C _{dyn}	C _{stat}					
				d ₁	d ₂	D ₁	D ₂	D ₄ TK	D ₅ H13	D ₆ h13	M	L _n	L ₁	L ₂	L ₃	L ₄	L ₇	L ₈ h13	i	D _w	B +0.5/0	b P9	t	S	SA	T _{max}				
4 × 1	...I	€€€	RH / -	4.0	3.2	8 g6	-	-	-	-	-	10	-	-	-	-	-	-	-	3 × 1	0.80	-	ø2 +0.1/0	1.0	-	-	0.03	430	580	4 × 1
5 × 2	...I	€€€	RH / -	5.0	4.0	10 g6	-	-	-	-	-	14	-	-	-	8	-	-	-	3 × 1	0.80	-	2	1.0	-	-	0.03	500	800	5 × 2
6 × 1	...I	€€€	RH / -	6.0	5.0	12 g6	-	-	-	-	-	14	-	-	-	8	-	-	-	3 × 1	0.80	-	2	1.2	-	-	0.03	600	1000	6 × 1
5 × 2	...I	€€	RH / -	5.0	4.0	10 0/-0.1	-	-	-	-	M8 × 0.75	18	-	6	-	-	-	-	-	3 × 1	0.80	2.5	-	-	-	-	0.03	500	800	5 × 2
5 × 3	...I	€€	RH / -	5.0	4.2	10 0/-0.1	-	-	-	-	M8 × 0.75	19	-	6	-	-	-	-	-	2 × 1	0.80	2.5	-	-	-	-	0.03	340	490	5 × 3
5 × 3	...I	€€	RH / -	5.0	4.2	10 0/-0.1	-	-	-	-	M8 × 0.75	23	-	6	-	-	-	-	-	3 × 1	0.80	2.5	-	-	-	-	0.03	480	770	5 × 3
6 × 2	...R	€€	RH / LH	5.7	4.6	16 0/-0.1	-	-	-	-	M12 × 1	22	-	8	-	-	-	-	-	1 × 3.5	1.59	2.5	-	-	-	0.06	1700	2300	6 × 2	
6 × 2	...F	€	RH / -	5.7	4.6	19 0/-0.1	-	-	-	-	M16 × 1	19	-	8	-	-	-	-	-	1 × 3.7	1.59	2.5	-	ø 2	K	0.05	1900	2800	6 × 2	
6 × 6	...F	€	RH / -	5.9	4.6	19 0/-0.1	-	-	-	-	M16 × 1	19	-	8	-	-	-	-	-	2 × 1.6	1.50	2.5	-	ø 2	K	0.05	1700	2600	6 × 6	
4 × 1	...I	€€€	RH / -	4.0	3.2	8 g6	7.9	12	2.7	17	-	14	2	-	-	-	3	11	3 × 1	0.80	-	-	-	-	-	0.03	430	580	4 × 1	
6 × 1	...I	€€€	RH / -	6.0	5.0	12 g6	11.8	18	3.4	24	-	18	4	-	-	-	4	16	3 × 1	0.80	-	-	-	ø 2	K	0.03	600	1000	6 × 1	
6 × 2	...F	€€	RH / -	5.7	4.6	18 -0.01/-0.05	17.5	26	3.4	34	-	19	4	-	4	-	4	-	-	1 × 3.7	1.59	-	-	-	ø 2	K	0.05	1900	2800	6 × 2
6 × 6	...F	€€	RH / -	5.9	4.6	18 -0.01/-0.05	17.5	26	3.4	34	-	19	4	-	4	-	4	-	-	2 × 1.6	1.50	-	-	-	ø 2	K	0.05	1700	2600	6 × 6

Ball return systems (details > page 9)



Single-thread ball return
Type ...I



Tube ball return
Type ...R



End cap ball return
Type ...E / ...F

Legend

- d₀ = nominal screw diameter [mm]
- d₁ = outer screw diameter [mm]
- d₂ = core diameter [mm]
- p = pitch [mm]

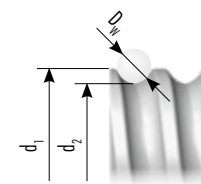

- i = number of ball circulations [-]
- D_w = ball diameter [mm]
- B = pin wrench hole* [mm]
- S = lubrication hole* [mm]
- SA = wipers (details > page 9)
- K = technopolymer wipers
- B = brush wipers
- F = felt rings (on request)

- T_{max} = max. standard backlash [mm]
- ³⁾ = only on request
- * position not defined
- Special designs available on request

⚠ When selecting a ballscrew, always observe the maximum rotational speed dependent on the system-specific rotational speed characteristics!
Calculation > page 12

> CAD data > www.gewinde.ch



ø 8

Cylindrical nut

ZY...

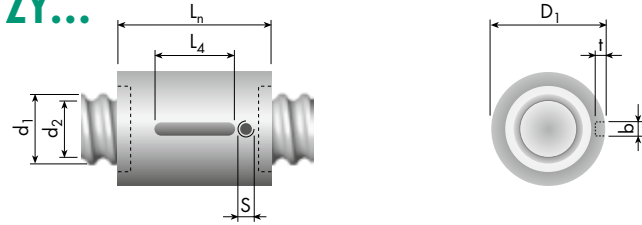

Nut with mounting thread

FG...

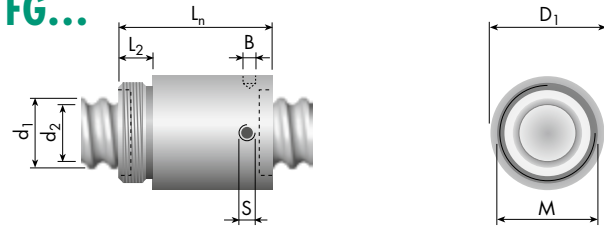

Flange nut

FB...

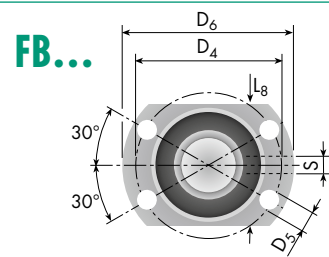

FA...

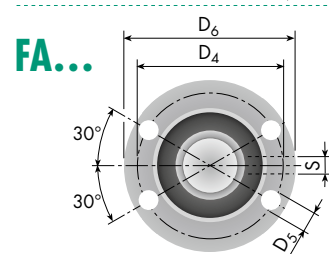

Nominal size d ₀ × p [mm]	Ball return Type	Relative cost	Right-/ left-hand thread	Dimensions [mm]																				Load rates [N]		Nominal size d ₀ × p [mm]			
				Screw										Nut										C _{dyn}	C _{stat}				
				d ₁	d ₂	D ₁	D ₂	D _{4 TK}	D _{5 H13}	D _{6 h13}	M	L ₆	L ₁	L ₂	L ₃	L ₄	L ₇	L _{8 h13}	i	D _w	B +0.5/0	b P9	t	S	SA	T _{max}			
8 × 1	...I	€€€	RH / -	8.0	7.0	14 g6	-	-	-	-	-	14	-	-	-	8	-	-	3 × 1	0.80	-	2	1.2	-	-	0.03	700	1200	8 × 1
8 × 1.5	...I	€€€	RH / -	8.0	6.7	14 g6	-	-	-	-	-	14	-	-	-	8	-	-	3 × 1	1.20	-	2	1.2	-	-	0.04	800	1300	8 × 1.5
8 × 2	...I	€€€	RH / -	8.0	6.5	16 g6	-	-	-	-	-	20	-	-	-	8	-	-	3 × 1	1.59	-	2	1.2	-	-	0.05	1400	2000	8 × 2
8 × 2	...R	€€€	RH / -	8.0	6.5	18 g6	-	-	-	-	-	14	-	-	-	8	-	-	1 × 3.5	1.59	-	2	1.2	-	-	0.06	2000	3200	8 × 2
8 × 2.5	...I	€€€	RH / -	8.0	6.6	16 g6	-	-	-	-	-	22	-	-	-	10	-	-	3 × 1	1.59	-	3	2.0	-	-	0.05	1400	2100	8 × 2.5
8 × 2.5	...I	€€€	RH / -	8.0	6.6	16 g6	-	-	-	-	-	22	-	-	-	10	-	-	3 × 1	1.59	-	3	2.0	ø 2	K	0.05	1400	2100	8 × 2.5
8 × 2.5	...R	€€€	RH / -	8.0	6.6	18 g6	-	-	-	-	-	16	-	-	-	10	-	-	1 × 3.5	1.59	-	3	2.0	-	-	0.06	2000	3200	8 × 2.5
8 × 3	...I	€€€	RH / -	8.0	6.7	14 g6	-	-	-	-	-	12	-	-	-	8	-	-	2 × 1	1.50	-	2	1.2	-	-	0.05	950	1500	8 × 3
8 × 3 ³⁾	...I	€€€	RH / -	8.0	6.7	14 g6	-	-	-	-	-	17	-	-	-	8	-	-	3 × 1	1.50	-	2	1.2	-	-	0.05	1400	2100	8 × 3 ³⁾
8 × 5	...R	€€€	RH / -	8.0	6.7	18 g6	-	-	-	-	-	19	-	-	-	10	-	-	2 × 2.5	1.50	-	3	2.0	-	-	0.06	1960	3470	8 × 5
8 × 12	...E	€€€	RH / -	8.0	6.7	18 g6	-	-	-	-	-	28	-	-	-	8	-	-	2 × 1.5	1.50	-	2	1.2	ø 2	K	0.05	1400	2300	8 × 12
8 × 1	...I	€€	RH / -	8.0	7.0	16 0/-0.1	-	-	-	-	M14 × 1	22	-	8	-	-	-	-	3 × 1	0.80	2.5	-	-	-	-	0.03	700	1200	8 × 1
8 × 1.5	...I	€€	RH / -	8.0	6.7	16 0/-0.1	-	-	-	-	M14 × 1	22	-	8	-	-	-	-	3 × 1	1.20	2.5	-	-	-	-	0.04	800	1300	8 × 1.5
8 × 2	...I	€€	RH / -	8.0	6.5	16 0/-0.1	-	-	-	-	M14 × 1	28	-	8	-	-	-	-	3 × 1	1.59	2.5	-	-	-	-	0.05	1400	2000	8 × 2
8 × 2	...R	€€	RH / -	8.0	6.5	18 0/-0.1	-	-	-	-	M14 × 1	24	-	8	-	-	-	-	1 × 3.5	1.59	2.5	-	-	-	-	0.06	2000	3200	8 × 2
8 × 2	...R	€€	RH / -	8.0	6.5	18 0/-0.1	-	-	-	-	M14 × 1	24	-	8	-	-	-	-	1 × 3.5	1.59	2.5	-	-	ø 2	K	0.06	2000	3200	8 × 2
8 × 2.5	...I	€€	RH / -	8.0	6.6	16 0/-0.1	-	-	-	-	M14 × 1	24	-	8	-	-	-	-	3 × 1	1.59	2.5	-	-	-	-	0.05	1400	2100	8 × 2.5
8 × 2.5	...R	€€	RH / -	8.0	6.6	17.5 0/-0.1	-	-	-	-	M15 × 1	24	-	8	-	-	-	-	1 × 3.5	1.59	2.5	-	-	-	-	0.06	2000	3200	8 × 2.5
8 × 2.5	...R	€€	RH / -	8.0	6.6	17.5 0/-0.1	-	-	-	-	M15 × 1	26	-	8	-	-	-	-	1 × 3.5	1.59	2.5	-	-	ø 2	K	0.06	2000	3200	8 × 2.5
8 × 3	...I	€€	RH / -	8.0	6.7	16 0/-0.1	-	-	-	-	M14 × 1	25	-	8	-	-	-	-	3 × 1	1.50	2.5	-	-	-	-	0.05	1400	2100	8 × 3
8 × 3	...F	€	RH / -	8.0	6.7	23 0/-0.1	-	-	-	-	M20 × 1	23	-	10	-	-	-	-	1 × 3.7	1.50	2.5	-	-	ø 2	K	0.05	1900	3300	8 × 3
8 × 5	...R	€€	RH / -	8.0	6.7	18 0/-0.1	-	-	-	-	M14 × 1	25	-	8	-	-	-	-	2 × 1.5	1.50	2.5	-	-	-	-	0.06	1960	3470	8 × 5
8 × 8	...R	€€	RH / -	8.0	6.6	18 0/-0.1	-	-	-	-	M14 × 1	25	-	8	-	-	-	-	2 × 1.5	1.50	2.5	-	-	-	-	0.06	1500	2500	8 × 8
8 × 8	...F	€	RH / -	8.0	6.6	23 0/-0.1	-	-	-	-	M20 × 1	23	-	10	-	-	-	-	2 × 1.7	1.50	2.5	-	-	ø 2	K	0.05	2000	3700	8 × 8
8 × 1	...I	€€€	RH / -	8.0	7.0	14 g6	13.5	21	3.4	27	-	18	4	-	-	-	4	18	3 × 1	0.80	-	-	-	ø 2	K	0.03	700	1200	8 × 1
8 × 2	...I	€€€	RH / -	8.0	6.5	16 g6	15.5	22	3.4	28	-	30	4	-	-	-	6	19	3 × 1	1.59	-	-	-	ø 4	K	0.05	1400	2000	8 × 2
8 × 2	...R	€€€	RH / -	8.0	6.5	18 g6	17.5	22	3.4	28	-	25	4	-	-	-	6	19	1 × 3.5	1.59	-	-	-	ø 4	K	0.06	2000	3200	8 × 2
8 × 8 ³⁾	...R	€€€	RH / -	8.0	6.6	18 g6	17.5	22	3.4	28	-	30	4	-	-	-	6	19	2 × 1.5	1.50	-	-	-	-	-	0.06	1500	2500	8 × 8 ³⁾
8 × 12	...E	€€	RH / -	8.0	6.7	18 g6	17.8	25	3.4	30	-	28	4	-	6	-	4	20	2 × 1.5	1.50	-	-	-	ø 2	K	0.05	1400	2300	8 × 12
8 × 3	...F	€€	RH / -	8.0	6.7	20 -0.01/-0.05	19.5	28	3.4	36	-	23	4	-	5	-	4	-	1 × 3.7	1.50	-	-	-	ø 2	K	0.05	1900	3300	8 × 3
8 × 8	...F	€€	RH / -	8.0	6.6	20 -0.01/-0.05	19.5	28	3.4	36	-	23	4	-	5	-	4	-	2 × 1.7	1.50	-	-	-	ø 2	K	0.05	2000	3700	8 × 8

Ball return systems (details > page 9)



Legend

- d₀ = nominal screw diameter [mm]
- d₁ = outer screw diameter [mm]
- d₂ = core diameter [mm]
- p = pitch [mm]

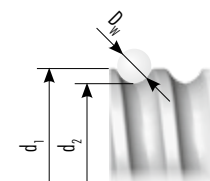

- i = number of ball circulations [-]
- D_w = ball diameter [mm]
- B = pin wrench hole* [mm]
- S = lubrication hole* [mm]
- SA = wipers (details > page 9)
- K = technopolymer wipers
- B = brush wipers
- F = felt rings (on request)

- T_{max} = max. standard backlash [mm]
- ³⁾ = only on request
- * position not defined
- Special designs available on request

⚠ When selecting a ballscrew, always observe the maximum rotational speed dependent on the system-specific rotational speed characteristics! Calculation > page 12

> CAD data > www.gewinde.ch



ø10

Cylindrical nut

ZY...

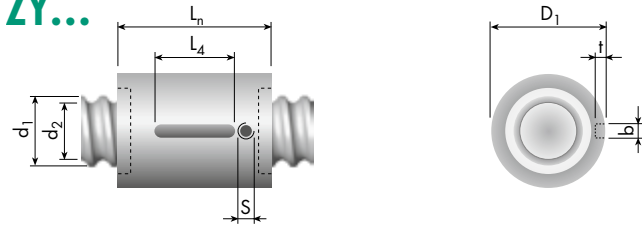

Nut with mounting thread

FG...

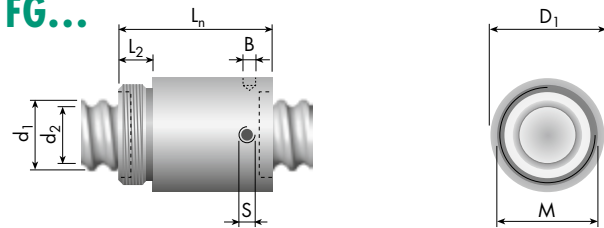

Flange nut

FB...

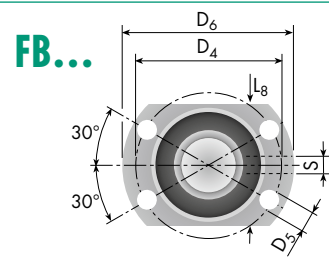

FA...

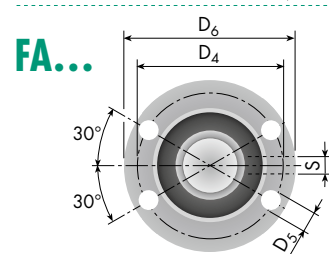

Nominal size d ₀ × p [mm]	Ball return Type	Relative cost	Right-/left-hand thread	Dimensions [mm]																				Load rates [N]		Nominal size d ₀ × p [mm]			
				Screw										Nut										C _{dyn}	C _{stat}				
				d ₁	d ₂	D ₁	D ₂	D _{4 TK}	D _{5 H13}	D _{6 h13}	M	L _n	L ₁	L ₂	L ₃	L ₄	L ₇	L _{8 h13}	i	D _w	B +0.5/0	b P9	t	S	SA	T _{max}			
10×2	...I	€€€	RH/LH	9.7	8.2	18 _{g6}	—	—	—	—	—	14	—	—	—	10	—	—	2×1	1.59	—	3	1.2	—	—	0.06	1250	2100	10×2
10×2 ³⁾	...I	€€€	RH/LH	9.7	8.2	18 _{g6}	—	—	—	—	—	20	—	—	—	10	—	—	3×1	1.59	—	3	1.2	—	—	0.06	1750	3200	10×2 ³⁾
10×3	...R	€€€	RH/LH	9.9	7.8	22 _{g6}	—	—	—	—	—	24	—	—	—	10	—	—	1×3.5	2.00	—	3	2.0	—	—	0.06	2800	5000	10×3
10×3	...R	€€€	RH/LH	9.9	7.8	22 _{g6}	—	—	—	—	—	24	—	—	—	10	—	—	1×3.5	2.00	—	3	2.0	ø 3.5	K	0.06	2800	5000	10×3
10×4	...I	€€€	RH/—	10.0	7.5	18 _{g6}	—	—	—	—	—	35	—	—	—	10	—	—	4×1	2.50	—	3	1.2	—	—	0.07	4100	6700	10×4
10×4	...I	€€€	RH/—	10.0	7.5	18 _{g6}	—	—	—	—	—	35	—	—	—	10	—	—	4×1	2.50	—	3	1.2	ø 2	K	0.07	4100	6700	10×4
10×10	...R	€€€	RH/—	9.8	7.9	23 _{g6}	—	—	—	—	—	26	—	—	—	10	—	—	2×1.5	2.00	—	3	2.0	—	—	0.06	2500	4500	10×10
10×2	...I	€€	RH/LH	9.7	8.2	18 _{0/-0.1}	—	—	—	—	M16×1	22	—	8	—	—	—	—	2×1	1.59	2.5	—	—	—	—	0.06	1250	2100	10×2
10×2 ³⁾	...I	€€	RH/LH	9.7	8.2	18 _{0/-0.1}	—	—	—	—	M16×1	28	—	8	—	—	—	—	3×1	1.59	2.5	—	—	—	—	0.06	1750	3200	10×2 ³⁾
10×2	...R	€€	RH/LH	9.7	8.2	19.5 _{0/-0.1}	—	—	—	—	M17×1	22	—	7	—	—	—	—	1×3.5	1.59	2.5	—	—	—	—	0.06	2300	4000	10×2
10×2	...R	€€	RH/—	9.7	8.2	19.5 _{0/-0.1}	—	—	—	—	M17×1	22	—	7	—	—	—	—	1×3.5	1.59	2.5	—	—	ø 2	K	0.06	2300	4000	10×2
10×3	...I	€€	RH/—	9.9	7.8	20 _{0/-0.1}	—	—	—	—	M18×1	29	—	8	—	—	—	—	3×1	2.00	2.5	—	—	—	—	0.06	2400	4200	10×3
10×3	...I	€€	RH/—	9.9	7.8	20 _{0/-0.1}	—	—	—	—	M18×1	29	—	8	—	—	—	—	3×1	2.00	2.5	—	—	ø 2	K	0.06	2400	4200	10×3
10×3	...R	€€	RH/LH	9.9	7.8	21 _{0/-0.1}	—	—	—	—	M18×1	29	—	9	—	—	—	—	1×3.5	2.00	3.0	—	—	—	—	0.06	2800	5000	10×3
10×3	...R	€€	RH/LH	9.9	7.8	21 _{0/-0.1}	—	—	—	—	M18×1	29	—	9	—	—	—	—	1×3.5	2.00	3.0	—	—	ø 2	K	0.06	2800	5000	10×3
10×3	...F	€	RH/—	9.9	7.8	27 _{0/-0.1}	—	—	—	—	M24×1.5	27	—	10	—	—	—	—	1×3.7	2.00	3.0	—	—	ø 2	K	0.06	3500	6300	10×3
10×4	...I	€€	RH/—	10.0	7.5	20 _{0/-0.1}	—	—	—	—	M18×1	40	—	8	—	—	—	—	4×1	2.50	2.5	—	—	—	—	0.07	4100	6700	10×4
10×4	...I	€€	RH/—	10.0	7.5	20 _{0/-0.1}	—	—	—	—	M18×1	40	—	8	—	—	—	—	4×1	2.50	2.5	—	—	ø 2	K	0.07	4100	6700	10×4
10×10	...R	€€	RH/—	9.8	7.9	23 _{0/-0.1}	—	—	—	—	M18×1	35	—	9	—	—	—	—	2×1.5	2.00	3.0	—	—	—	—	0.06	2500	4500	10×10
10×10	...R	€€	RH/—	9.8	7.9	23 _{0/-0.1}	—	—	—	—	M18×1	35	—	9	—	—	—	—	2×1.5	2.00	3.0	—	—	ø 4	K	0.06	2500	4500	10×10
10×10	...F	€	RH/—	9.9	7.9	27 _{0/-0.1}	—	—	—	—	M24×1.5	27	—	10	—	—	—	—	2×1.7	2.00	3.0	—	—	ø 2	K	0.06	3200	5900	10×10
10×4	...I	€€€	RH/—	10.0	7.5	18 _{g6}	17.8	28	4.5	36	—	38	6	—	—	—	6	23	4×1	2.50	—	—	—	—	—	0.07	4100	6700	10×4
10×4	...I	€€€	RH/—	10.0	7.5	18 _{g6}	17.8	28	4.5	36	—	38	6	—	—	—	6	23	4×1	2.50	—	—	—	ø 2	K	0.07	4100	6700	10×4
10×10	...R	€€€	RH/—	9.8	7.9	23 _{g6}	22.5	29	4.5	37	—	40	6	—	—	—	8	24	2×1.5	2.00	—	—	—	M5	K	0.06	2500	4500	10×10
10×3	...F	€€	RH/—	9.9	7.8	24 _{-0.01/-0.06}	23.5	32	4.5	40	—	27	5	—	4	—	7	—	1×3.7	2.00	—	—	—	ø 3	K	0.06	3500	6300	10×3
10×10	...F	€€	RH/—	9.8	7.9	24 _{-0.01/-0.06}	23.5	32	4.5	40	—	27	5	—	4	—	7	—	2×1.7	2.00	—	—	—	ø 4	K	0.06	3200	5900	10×10

Ball return systems (details > page 9)



Legend

- d₀ = nominal screw diameter [mm]
- d₁ = outer screw diameter [mm]
- d₂ = core diameter [mm]
- p = pitch [mm]

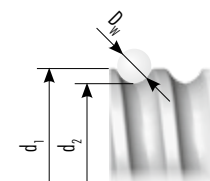

- i = number of ball circulations [—]
- D_w = ball diameter [mm]
- B = pin wrench hole* [mm]
- S = lubrication hole* [mm]
- SA = wipers (details > page 9)
- K = technopolymer wipers
- B = brush wipers
- F = felt rings (on request)

- T_{max} = max. standard backlash [mm]
- ³⁾ = only on request
- * position not defined
- Special designs available on request

⚠ When selecting a ballscrew, always observe the maximum rotational speed dependent on the system-specific rotational speed characteristics! Calculation > page 12

> CAD data > www.gewinde.ch



ø12

Cylindrical nut

ZY...

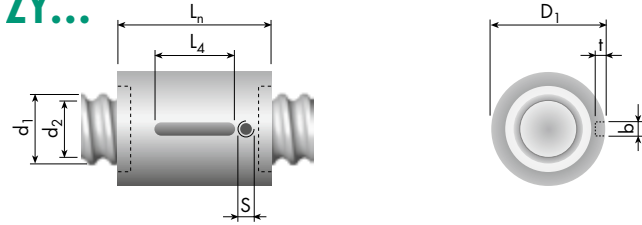

Nut with mounting thread

FG...

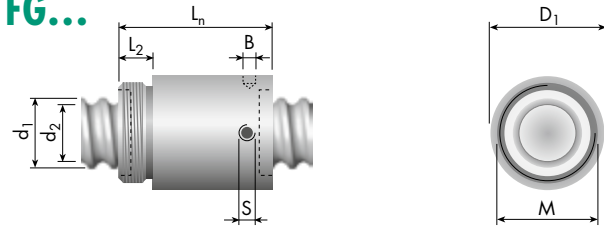

Flange nut

FB...

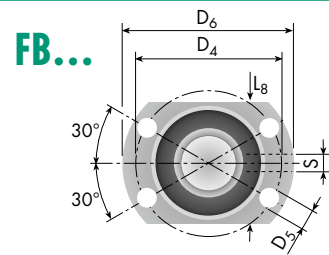

FA...

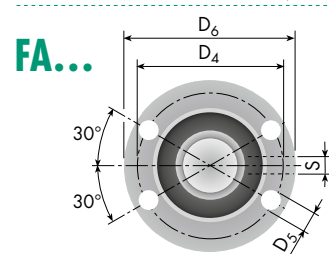

Nominal size d ₀ × p [mm]	Ball return Type	Relative cost	Right-/ left-hand thread	Dimensions [mm]																				Load rates [N]		Nominal size d ₀ × p [mm]			
				Screw										Nut										C _{dyn}	C _{stat}				
				d ₁	d ₂	D ₁	D ₂	D ₄ TK	D ₅ H13	D ₆ h13	M	L _n	L ₁	L ₂	L ₃	L ₄	L ₇	L ₈ h13	i	D _w	B +0.5/0	b P9	t	S	SA	T _{max}			
12×2	...I	€€€	RH / -	12.0	10.6	20 g6	-	-	-	-	-	15	-	-	-	10	-	-	2×1	1.59	-	3	1.2	-	-	0.06	1380	2500	12×2
12×2 ³⁾	...I	€€€	RH / LH	12.0	10.6	20 g6	-	-	-	-	-	20	-	-	-	10	-	-	3×1	1.59	-	3	1.2	-	-	0.06	2000	4000	12×2 ³⁾
12×4	...R	€€€	RH / -	12.0	9.8	26 g6	-	-	-	-	-	24	-	-	-	10	-	-	1×3.5	2.50	-	3	1.8	-	-	0.07	5500	11000	12×4
12×4	...R	€€€	RH / -	12.0	9.8	26 g6	-	-	-	-	-	32	-	-	-	10	-	-	1×3.5	2.50	-	3	1.8	ø 4	K	0.07	5500	11000	12×4
12×2	...I	€€	RH / -	12.0	10.6	20 0/-0.1	-	-	-	-	M18×1	23	-	8	-	-	-	-	2×1	1.59	2.5	-	-	-	-	0.06	1380	2500	12×2
12×2 ³⁾	...I	€€	RH / LH	12.0	10.6	20 0/-0.1	-	-	-	-	M18×1	28	-	8	-	-	-	-	3×1	1.59	2.5	-	-	-	-	0.06	2000	4000	12×2 ³⁾
12×4	...I	€€	RH / -	12.0	9.8	24 0/-0.1	-	-	-	-	M20×1	39	-	10	-	-	-	-	3×1	2.50	2.5	-	-	-	-	0.07	4000	6800	12×4
12×4	...I	€€	RH / -	12.0	9.8	24 0/-0.1	-	-	-	-	M20×1	39	-	10	-	-	-	-	3×1	2.50	2.5	-	-	ø 4	K	0.07	4000	6800	12×4
12×4	...R	€€	RH / -	12.0	9.8	26 0/-0.1	-	-	-	-	M20×1	32	-	8	-	-	-	-	1×3.5	2.50	2.5	-	-	-	-	0.07	5500	11000	12×4
12×4	...R	€€	RH / -	12.0	9.8	26 0/-0.1	-	-	-	-	M20×1	34	-	10	-	-	-	-	1×3.5	2.50	2.5	-	-	ø 4	K	0.07	5500	11000	12×4
12×5	...I	€€	RH / -	12.0	9.5	23 0/-0.1	-	-	-	-	M20×1	42	-	10	-	-	-	-	3×1	2.78	3.0	-	-	-	-	0.07	5000	8600	12×5
12×5	...I	€€	RH / -	12.0	9.5	23 0/-0.1	-	-	-	-	M20×1	42	-	10	-	-	-	-	3×1	2.78	3.0	-	-	ø 4	K	0.07	5000	8600	12×5
12×5	...R	€€	RH / LH	12.0	9.5	26 0/-0.1	-	-	-	-	M20×1	37	-	8	-	-	-	-	1×3.5	2.78	3.0	-	-	-	-	0.07	6600	12000	12×5
12×5	...R	€€	RH / -	12.0	9.5	26 0/-0.1	-	-	-	-	M20×1	37	-	8	-	-	-	-	1×3.5	2.78	3.0	-	-	ø 4	K	0.07	6600	12000	12×5
12×5	...F	€	RH / -	12.0	9.5	32 0/-0.1	-	-	-	-	M28×1.5	30	-	12	-	-	-	-	1×3.7	2.78	3.5	-	-	ø 4	K	0.06	5900	10600	12×5
12×10	...R	€€	RH / -	11.9	9.7	26 0/-0.1	-	-	-	-	M20×1	37	-	8	-	-	-	-	2×1.5	2.50	3.0	-	-	-	-	0.07	4400	7700	12×10
12×10	...F	€	RH / -	11.9	9.7	32 0/-0.1	-	-	-	-	M28×1.5	38	-	12	-	-	-	-	2×2.4	2.50	3.5	-	-	ø 4	K	0.06	6400	12600	12×10
12×12	...F	€	RH / -	12.0	9.7	32 0/-0.1	-	-	-	-	M28×1.5	30	-	12	-	-	-	-	2×1.6	2.50	3.5	-	-	ø 4	K	0.06	4600	8500	12×12
12×2	...R	€€€	RH / -	12.0	10.6	22 g6	21.5	29	4.5	37	-	30	5	-	-	8	24	1×3.5	1.59	-	-	-	-	ø 4	K	0.06	2500	5100	12×2
12×3	...R	€€€	RH / -	12.3	10.2	24 g6	23.5	32	4.5	40	-	36	5	-	-	8	26	2×2.5	2.00	-	-	-	-	-	0.06	5000	11000	12×3	
12×4	...R	€€€	RH / -	12.0	9.8	26 g6	25.5	32	4.5	39.5	-	36	5	-	-	8	28	1×3.5	2.50	-	-	-	M5	K	0.07	5500	11000	12×4	
12×5	...I	€€€	RH / -	12.0	9.5	24 g6	23.5	32	4.5	40	-	40	6	-	-	8	26	3×1	2.78	-	-	-	ø 4	K	0.07	5000	8600	12×5	
12×5	...R	€€€	RH / -	12.0	9.5	26 g6	25.5	32	4.5	39.5	-	40	5	-	-	7	28	1×3.5	2.78	-	-	-	M5	K	0.07	6600	12000	12×5	
12×5	...F	€€	RH / -	12.0	9.5	26 -0.01/-0.06	25.5	34	4.5	42	-	30	6	-	6	-	8	-	1×3.7	2.78	-	-	-	ø 4	K	0.06	5900	10600	12×5
12×10	...F	€€	RH / -	11.9	9.7	26 -0.01/-0.06	25.5	34	4.5	42	-	38	6	-	6	-	8	-	2×2.4	2.50	-	-	-	ø 4	K	0.06	6400	12600	12×10
12×12	...F	€€	RH / -	12.0	9.7	26 -0.01/-0.06	25.5	34	4.5	42	-	30	6	-	6	-	8	-	2×1.6	2.50	-	-	-	ø 4	K	0.06	4600	8500	12×12

Ball return systems (details > page 9)



Legend

- d₀ = nominal screw diameter [mm]
- d₁ = outer screw diameter [mm]
- d₂ = core diameter [mm]
- p = pitch [mm]

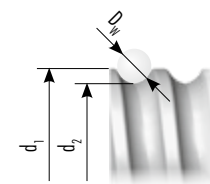

- i = number of ball circulations [-]
- D_w = ball diameter [mm]
- B = pin wrench hole* [mm]
- S = lubrication hole* [mm]
- SA = wipers (details > page 9)
- K = technopolymer wipers
- B = brush wipers
- F = felt rings (on request)

- T_{max} = max. standard backlash [mm]
- ³⁾ = only on request
- * position not defined
- Special designs available on request

⚠ When selecting a ballscrew, always observe the maximum rotational speed dependent on the system-specific rotational speed characteristics! Calculation > page 12

> CAD data > www.gewinde.ch



ø 12.7 (1/2")

Cylindrical nut

ZY...

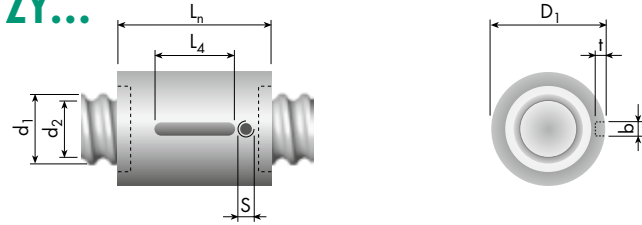

Nut with mounting thread

FG...

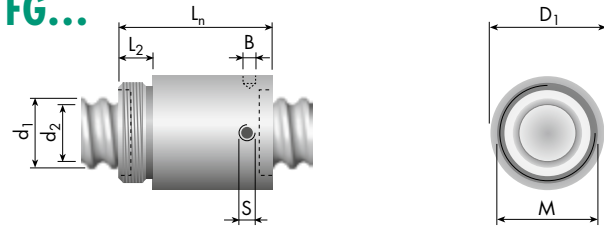

Flange nut

FB...

FA...

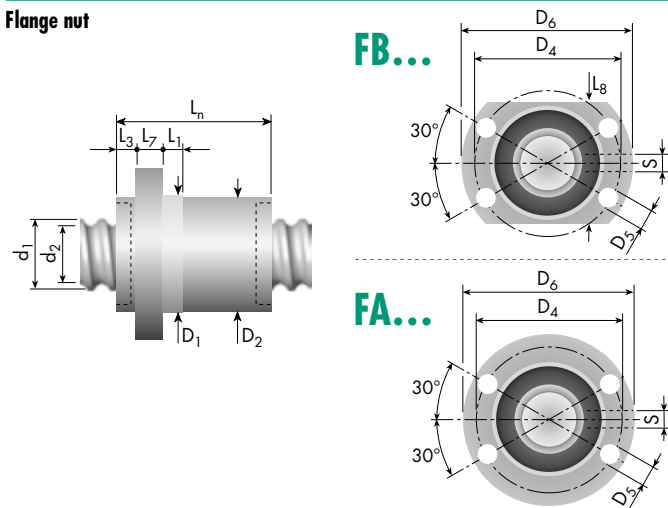

Nominal size d ₀ × p [mm] (in)	Ball return Type	Relative cost	Right-/ left-hand thread	Dimensions [mm]																				Load rates [N]		Nominal size d ₀ × p [mm]			
				Screw d ₁	d ₂	Nut D ₁	D ₂	D ₄ TK	D ₅ H13	D ₆ h13	M	L _n	L ₁	L ₂	L ₃	L ₄	L ₇	L ₈ h13	i	D _w	B +0.5/0	b P9	t	S	SA		T _{max}	C _{dyn}	C _{stat}
12.7 × 25.4 (1/2" × 1")	...E	€€€	RH / -	12.5	10.6	26 g6	-	-	-	-	-	32	-	-	-	10	-	-	3 × 0.9	2.00	-	3	1.8	ø 4	K	0.05	2300	4500	12.7 × 25.4
12.7 × 12.7 (1/2" × 1/2")	...R	€€	RH / -	13.1	10.3	29.5 0/-0.1	-	-	-	-	M25 × 1.5	50	-	12	-	-	-	2 × 1.5	3.50	3.0	-	-	-	-	0.07	8000	15500	12.7 × 12.7	
12.7 × 12.7 (1/2" × 1/2")	...R	€€	RH / -	13.1	10.3	29.5 0/-0.1	-	-	-	-	M25 × 1.5	50	-	12	-	-	-	2 × 1.5	3.50	3.0	-	-	M5	B	0.07	8000	15500	12.7 × 12.7	
12.7 × 25.4 (1/2" × 1")	...E	€€	RH / -	12.5	10.6	26 g6	25.5	33	4.5	42	-	32	5	-	7	-	8	28	3 × 0.9	2.00	-	-	-	ø 4	K	0.05	2300	4500	12.7 × 25.4

Ball return systems (details > page 9)



Legend

- d₀ = nominal screw diameter [mm]
- d₁ = outer screw diameter [mm]
- d₂ = core diameter [mm]
- p = pitch [mm]

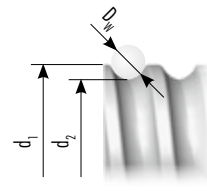

- i = number of ball circulations [-]
- D_w = ball diameter [mm]
- B = pin wrench hole* [mm]
- S = lubrication hole* [mm]
- SA = wipers (details > page 9)
- K = technopolymer wipers
- B = brush wipers
- F = felt rings (on request)

- T_{max} = max. standard backlash [mm]
- ³⁾ = only on request
- * position not defined
- Special designs available on request

⚠ When selecting a ballscrew, always observe the maximum rotational speed dependent on the system-specific rotational speed characteristics! Calculation > page 12

> CAD data > www.gewinde.ch

ø 12.7 (1/2")



ø 14

Cylindrical nut

ZY...

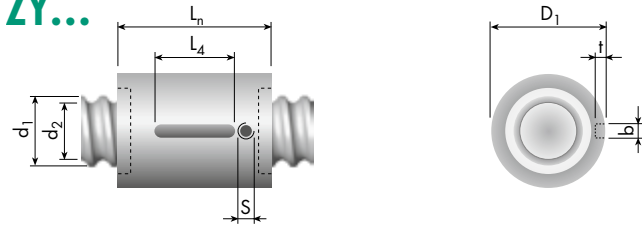

Nut with mounting thread

FG...

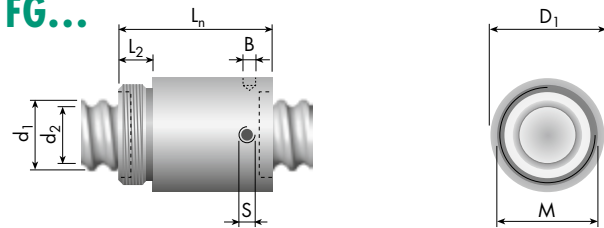

Flange nut

FB...

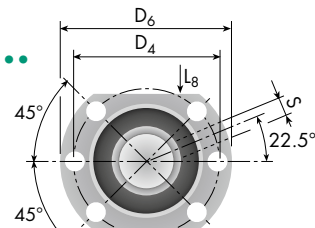

FA...

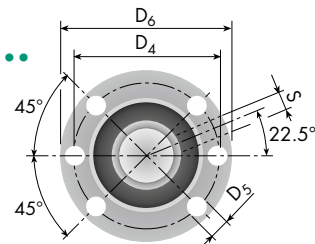

Nominal size d ₀ × p [mm]	Ball return Type	Relative cost	Right-/ left-hand thread	Dimensions [mm]																				Load rates [N]		Nominal size d ₀ × p [mm]			
				Screw										Nut										C _{dyn}	C _{stat}				
				d ₁	d ₂	D ₁	D ₂	D ₄ TK	D ₅ H13	D ₆ h13	M	L _n	L ₁	L ₂	L ₃	L ₄	L ₇	L ₈ h13	i	D _w	B +0.5/0	b P9	t	S	SA	T _{max}			
14 × 4	...I	€€€	RH / —	14.0	11.5	25 g6	—	—	—	—	—	24	—	—	—	10	—	—	3 × 1	2.78	—	4	2.5	—	—	0.07	5000	8800	14 × 4
14 × 4	...I	€€€	RH / —	14.0	11.5	25 g6	—	—	—	—	—	32	—	—	—	10	—	—	3 × 1	2.78	—	4	2.5	ø 4	K	0.07	5000	8800	14 × 4
14 × 4	...R	€€€	RH / LH	14.0	11.5	29 g6	—	—	—	—	—	24	—	—	—	16	—	—	1 × 3.5	2.78	—	4	2.5	—	—	0.07	8100	16000	14 × 4
14 × 4	...R	€€€	RH / LH	14.0	11.5	29 g6	—	—	—	—	—	32	—	—	—	16	—	—	1 × 3.5	2.78	—	4	2.5	ø 4	K	0.07	8100	16000	14 × 4
14 × 2	...R	€€	RH / —	14.0	12.5	26 0/-0.1	—	—	—	—	M22 × 1.5	32	—	10	—	—	—	—	2 × 2.5	1.59	3.0	—	—	—	—	0.06	4500	10000	14 × 2
14 × 2	...R	€€	RH / —	14.0	12.5	26 0/-0.1	—	—	—	—	M22 × 1.5	32	—	10	—	—	—	—	2 × 2.5	1.59	3.0	—	—	ø 2	K	0.06	4500	10000	14 × 2
14 × 4	...I	€€	RH / —	14.0	11.5	25 0/-0.1	—	—	—	—	M22 × 1.5	34	—	10	—	—	—	—	3 × 1	2.78	2.5	—	—	—	—	0.07	5000	8800	14 × 4
14 × 4	...I	€€	RH / —	14.0	11.5	25 0/-0.1	—	—	—	—	M22 × 1.5	38	—	10	—	—	—	—	3 × 1	2.78	2.5	—	—	ø 4	K	0.07	5000	8800	14 × 4
14 × 4	...R	€€	RH / LH	14.0	11.5	29 0/-0.1	—	—	—	—	M22 × 1.5	32	—	8	—	—	—	—	1 × 3.5	2.78	3.0	—	—	—	—	0.07	8100	16000	14 × 4
14 × 4	...R	€€	RH / LH	14.0	11.5	29 0/-0.1	—	—	—	—	M22 × 1.5	38	—	10	—	—	—	—	1 × 3.5	2.78	3.0	—	—	ø 4	K	0.07	8100	16000	14 × 4
14 × 2	...R	€€€	RH / —	14.0	12.5	26 g6	25.5	32	4.5	39.5	—	32	5	—	—	—	7	28	2 × 2.5	1.59	—	—	—	ø 4	K	0.06	4500	10000	14 × 2
14 × 4	...R	€€€	RH / LH	14.0	11.5	29 g6	28.6	38	5.5	48	—	40	6	—	—	—	8	36	1 × 3.5	2.78	—	—	—	M5	K	0.07	8100	16000	14 × 4

Ball return systems (details > page 9)



Single-thread ball return
Type ...I



Tube ball return
Type ...R



End cap ball return
Type ...E / ...F

Legend

- d₀ = nominal screw diameter [mm]
- d₁ = outer screw diameter [mm]
- d₂ = core diameter [mm]
- p = pitch [mm]

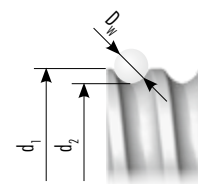

- i = number of ball circulations [-]
- D_w = ball diameter [mm]
- B = pin wrench hole* [mm]
- S = lubrication hole* [mm]

- SA = wipers (details > page 9)
- K = technopolymer wipers
- B = brush wipers
- F = felt rings (on request)

- T_{max} = max. standard backlash [mm]
- ³⁾ = only on request
- * position not defined
- Special designs available on request

⚠ When selecting a ballscrew, always observe the maximum rotational speed dependent on the system-specific rotational speed characteristics!
Calculation > page 12

> CAD data > www.gewinde.ch



ø15/16

Cylindrical nut

ZY...

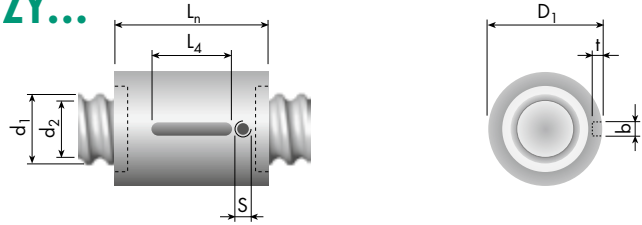

Nut with mounting thread

FG...

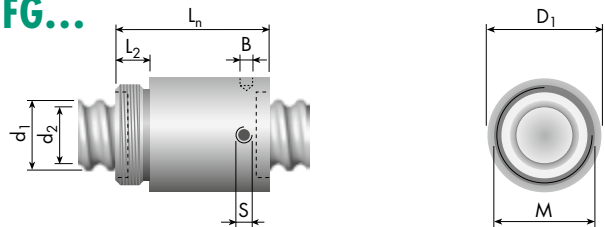

Flange nut

FB...

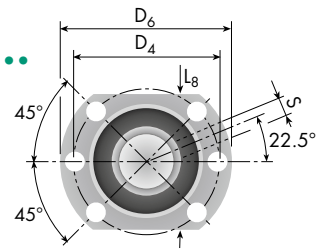

FA...

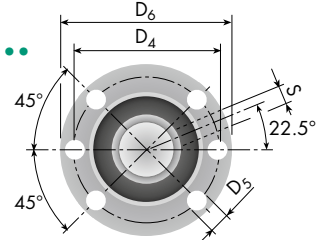

Nominal size d ₀ × p [mm]	Ball return Type	Relative cost	Right-/ left-hand thread	Dimensions [mm]																				Load rates [N]		Nominal size d ₀ × p [mm]			
				Screw		Nut																		C _{dyn}	C _{stat}				
				d ₁	d ₂	D ₁	D ₂	D _{4 TK}	D _{5 H13}	D _{6 h13}	M	L ₈	L ₁	L ₂	L ₃	L ₄	L ₇	L _{8 h13}	i	D _w	B +0.5/0	b P9	t	S	SA	T _{max}			
16 × 5	...I	€€€	RH/LH	15.7	13.0	30 _{g6}	—	—	—	—	—	43	—	—	—	16	—	—	3 × 1	3.50	—	4	2.5	M5	K	0.07	9700	22000	16 × 5
16 × 10	...R	€€€	RH/—	15.7	13.0	32 _{g6}	—	—	—	—	—	45	—	—	—	16	—	—	2 × 2.5	3.50	—	4	2.5	—	—	0.07	17000	25000	16 × 10
16 × 10	...R	€€€	RH/—	15.7	13.0	32 _{g6}	—	—	—	—	—	45	—	—	—	16	—	—	2 × 2.5	3.50	—	4	2.5	ø 4	K	0.07	17000	25000	16 × 10
16 × 10	...E	€€€	RH/—	16.0	13.4	28 _{g6}	—	—	—	—	—	42	—	—	—	16	—	—	2 × 2.9	3.00	—	4	2.5	ø 4	K	0.07	12500	26000	16 × 10
16 × 16	...E	€€€	RH/—	15.5	13.2	28 _{g6}	—	—	—	—	—	42	—	—	—	16	—	—	2 × 1.9	3.00	—	4	2.5	ø 3	K	0.07	7800	15500	16 × 16
16 × 50	...E	€€€	RH/—	16.0	13.2	28 _{g6}	—	—	—	—	—	55	—	—	—	16	—	—	3 × 0.9	3.00	—	4	2.5	ø 4	K	0.06	4800	11000	16 × 50
15 × 20	...F	€	RH/—	14.9	12.0	36 _{0/-0.1}	—	—	—	—	M33 × 1.5	46	—	19	—	—	—	—	2 × 1.7	3.00	4.0	—	—	ø 4	K	0.07	7100	14700	15 × 20
16 × 2	...I	€€	—/LH	16.0	14.5	25 _{0/-0.1}	—	—	—	—	M22 × 1.5	34	—	10	—	—	—	—	3 × 1	1.59	2.5	—	—	—	—	0.05	2400	5200	16 × 2
16 × 2	...R	€€	RH/—	16.0	14.5	30 _{0/-0.1}	—	—	—	—	M26 × 1.5	28	—	12	—	—	—	—	1 × 2.5	1.59	3.5	—	—	—	—	0.06	2500	5500	16 × 2
16 × 2	...R	€€	RH/—	16.0	14.5	30 _{0/-0.1}	—	—	—	—	M26 × 1.5	28	—	12	—	—	—	—	1 × 2.5	1.59	3.5	—	—	ø 2	K	0.06	2500	5500	16 × 2
16 × 5	...I	€€	RH/—	15.7	13.0	30.2 _{0/-0.1}	—	—	—	—	M26 × 1.5	45	—	12	—	—	—	—	3 × 1	3.50	3.5	—	—	—	—	0.07	9700	22000	16 × 5
16 × 5	...I	€€	RH/LH ³⁾	15.7	13.0	30.2 _{0/-0.1}	—	—	—	—	M26 × 1.5	50	—	12	—	—	—	—	3 × 1	3.50	3.5	—	—	M5	K	0.07	9700	22000	16 × 5
16 × 5	...R	€€	RH/LH	15.7	13.0	32 _{0/-0.1}	—	—	—	—	M26 × 1.5	42	—	12	—	—	—	—	1 × 3.5	3.50	4.0	—	—	—	—	0.07	12000	25000	16 × 5
16 × 5	...R	€€	RH/LH	15.7	13.0	32 _{0/-0.1}	—	—	—	—	M26 × 1.5	47	—	12	—	—	—	—	1 × 3.5	3.50	4.0	—	—	M5	K	0.07	12000	25000	16 × 5
16 × 10	...R	€€	RH/—	15.7	13.0	32 _{0/-0.1}	—	—	—	—	M26 × 1.5	47	—	12	—	—	—	—	1 × 2.5	3.50	4.0	—	—	—	—	0.07	8500	12500	16 × 10
16 × 10	...R	€€	RH/—	15.7	13.0	32 _{0/-0.1}	—	—	—	—	M26 × 1.5	52	—	12	—	—	—	—	1 × 2.5	3.50	4.0	—	—	ø 4	K	0.07	8500	12500	16 × 10
16 × 10	...R	€€	RH/—	15.7	13.0	32 _{0/-0.1}	—	—	—	—	M26 × 1.5	47	—	12	—	—	—	—	2 × 2.5	3.50	4.0	—	—	—	—	0.07	17000	25000	16 × 10
16 × 10	...R	€€	RH/—	15.7	13.0	32 _{0/-0.1}	—	—	—	—	M26 × 1.5	52	—	12	—	—	—	—	2 × 2.5	3.50	4.0	—	—	ø 4	K	0.07	17000	25000	16 × 10
16 × 16	...R	€€	RH/—	15.9	13.2	32 _{0/-0.1}	—	—	—	—	M26 × 1.5	47	—	12	—	—	—	—	3 × 1.5	3.00	4.0	—	—	—	—	0.07	9150	18750	16 × 16
16 × 16	...F	€	RH/—	15.5	13.2	36 _{0/-0.1}	—	—	—	—	M33 × 1.5	41	—	19	—	—	—	—	2 × 1.6	3.00	4.0	—	—	ø 4	K	0.07	6700	13700	16 × 16
16 × 2	...R	€€€	RH/—	16.0	14.5	30 _{g6}	29.5	38	5.5	48	—	45	6	—	—	—	10	40	2 × 2.5	1.59	—	—	—	M6	K	0.06	4500	11000	16 × 2
16 × 2	...R	€€€	RH/—	16.0	14.5	30 _{g6}	29.5	38	5.5	48	—	45	6	—	—	—	10	40	3 × 2.5	1.59	—	—	—	M6	K	0.06	6000	15000	16 × 2
16 × 5	...I	€€€	RH/LH	15.7	13.0	28 _{g6}	27.8	38	5.5	48	—	45	6	—	—	—	10	40	3 × 1	3.50	—	—	—	M6	K	0.07	9700	22000	16 × 5
16 × 10	...R	€€€	RH/—	15.7	13.0	32 _{g6}	31.5	43	6.6	54	—	52	6	—	—	—	12	44	2 × 2.5	3.50	—	—	—	M6	K	0.07	17000	25000	16 × 10
16 × 10	...E	€€	RH/—	16.0	13.4	28 _{g6}	27.8	38	5.5	48	—	42	10	—	10	—	10	40	2 × 2.9	3.00	—	—	—	ø 4	K	0.07	12500	26000	16 × 10
16 × 16	...E	€€	RH/—	15.5	13.2	28 _{g6}	27.8	38	5.5	48	—	42	10	—	10	—	10	40	2 × 1.9	3.00	—	—	—	ø 4	K	0.07	7800	15500	16 × 16
16 × 50	...E	€€	RH/—	16.0	13.2	28 _{g6}	27.8	38	5.5	48	—	55	10	—	10	—	10	40	3 × 0.9	3.00	—	—	—	ø 4	K	0.06	4800	11000	16 × 50
15 × 20	...F	€€	RH/—	14.9	12.0	32 _{-0.01/-0.07}	31.5	42	5.5	52	—	46	10	—	10	—	10	—	2 × 1.7	3.00	—	—	—	ø 4	K	0.07	7100	14700	15 × 20
16 × 16	...F	€€	RH/—	15.5	13.2	32 _{-0.01/-0.07}	31.5	42	5.5	52	—	41	10	—	10	—	10	—	2 × 1.6	3.00	—	—	—	ø 4	K	0.07	6700	13700	16 × 16

Ball return systems (details > page 9)



Legend

- d₀ = nominal screw diameter [mm]
- d₁ = outer screw diameter [mm]
- d₂ = core diameter [mm]
- p = pitch [mm]

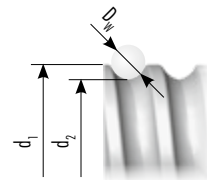

- i = number of ball circulations [—]
- D_w = ball diameter [mm]
- B = pin wrench hole* [mm]
- S = lubrication hole* [mm]
- SA = wipers (details > page 9)
- K = technopolymer wipers
- B = brush wipers
- F = felt rings (on request)

- T_{max} = max. standard backlash [mm]
- ³⁾ = only on request
- * position not defined
- Special designs available on request

⚠ When selecting a ballscrew, always observe the maximum rotational speed dependent on the system-specific rotational speed characteristics! Calculation > page 12

ø15/16

> CAD data > www.gewinde.ch



ø 20

Cylindrical nut

ZY...

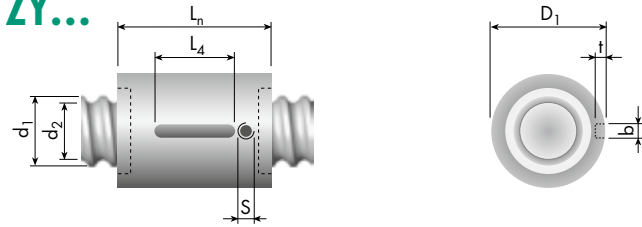

Nut with mounting thread

FG...

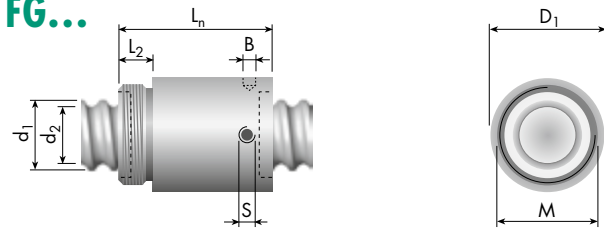

Flange nut

FB...

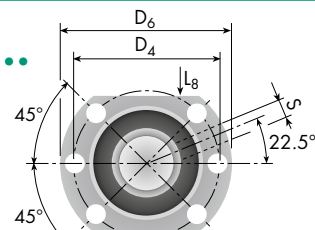

FA...

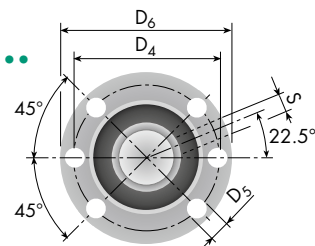

Nominal size d ₀ × p [mm]	Ball return Type	Relative cost	Right-/ left-hand thread	Dimensions [mm]																				Load rates [N]		Nominal size d ₀ × p [mm]			
				Screw										Nut										C _{dyn}	C _{stat}				
				d ₁	d ₂	D ₁	D ₂	D ₄ TK	D ₅ H13	D ₆ h13	M	L _n	L ₁	L ₂	L ₃	L ₄	L ₇	L ₈ h13	i	D _w	B +0.5/0	b P9	t	S	SA	T _{max}			
20 × 5	...I	€€€	RH/LH	19.2	16.5	33 g6	—	—	—	—	—	45	—	—	—	20	—	—	3 × 1	3.50	—	4	2.5	M5	K	0.07	10 800	25 000	20 × 5
20 × 20	...E	€€€	RH/—	20.0	17.3	36 g6	—	—	—	—	—	50	—	—	—	20	—	—	4 × 1.9	3.00	—	4	2.5	ø 4	K	0.06	17 900	44 600	20 × 20
20 × 2	...R	€€	RH/LH	20.0	18.5	36 0/-0.1	—	—	—	—	M30 × 1.5	30	—	12	—	—	—	—	2 × 2.5	1.59	4.0	—	—	—	—	0.06	4 600	15 000	20 × 2
20 × 5	...I	€€	RH/LH	19.2	16.5	33 0/-0.1	—	—	—	—	M30 × 1.5	47	—	12	—	—	—	—	3 × 1	3.50	4.0	—	—	M5	K	0.07	10 800	25 000	20 × 5
20 × 5	...R	€€	RH/—	19.2	16.5	36 0/-0.1	—	—	—	—	M30 × 1.5	42	—	12	—	—	—	—	1 × 3.5	3.50	4.0	—	—	—	—	0.07	13 700	29 900	20 × 5
20 × 5	...R	€€	RH/—	19.2	16.5	36 0/-0.1	—	—	—	—	M30 × 1.5	47	—	12	—	—	—	—	1 × 3.5	3.50	4.0	—	—	ø 4	K	0.07	13 700	29 900	20 × 5
20 × 10	...R	€€	RH/—	19.5	16.5	38 0/-0.1	—	—	—	—	M35 × 1.5	58	—	19	—	—	—	—	2 × 2.5	3.50	4.0	—	—	—	—	0.07	21 000	51 000	20 × 10
20 × 10	...R	€€	RH/—	19.5	16.5	38 0/-0.1	—	—	—	—	M35 × 1.5	58	—	19	—	—	—	—	2 × 2.5	3.50	4.0	—	—	ø 4	B	0.07	21 000	51 000	20 × 10
20 × 20	...R	€€	RH/—	20.0	16.5	38 0/-0.1	—	—	—	—	M35 × 1.5	58	—	19	—	—	—	—	2 × 1.5	3.50	4.0	—	—	—	—	0.07	10 000	22 000	20 × 20
20 × 20	...R	€€	RH/—	20.0	16.5	38 0/-0.1	—	—	—	—	M35 × 1.5	64	—	19	—	—	—	—	2 × 1.5	3.50	4.0	—	—	ø 4	B	0.07	10 000	22 000	20 × 20
20 × 20	...R	€€	RH/—	20.0	17.3	38 0/-0.1	—	—	—	—	M35 × 1.5	58	—	19	—	—	—	—	4 × 1.5	3.00	4.0	—	—	—	—	0.07	14 600	35 000	20 × 20
20 × 5	...I	€€€	RH/LH	19.2	16.5	36 g6	35.5	47	6.6	58	—	50	10	—	—	—	10	44	3 × 1	3.50	—	—	—	M6	K	0.07	10 800	25 000	20 × 5
20 × 10	...R	€€€	RH/—	19.5	16.5	38 g6	37.5	50	6.6	62	—	55	7	—	—	—	10	48	2 × 2.5	3.50	—	—	—	M6	B	0.07	21 000	51 000	20 × 10
20 × 10 ³⁾	...R	€€€	RH/—	19.5	16.5	38 g6	37.5	50	6.6	62	—	65	7	—	—	—	10	48	2 × 3.5	3.50	—	—	—	M6	B	0.07	26 000	65 000	20 × 10 ³⁾
20 × 20	...R	€€€	RH/—	20.0	16.5	36 g6	35.5	47	6.6	58	—	58	7	—	—	—	10	44	2 × 1.5	3.50	—	—	—	M6	B	0.07	10 000	22 000	20 × 20
20 × 20	...E	€€	RH/—	20.0	17.3	36 g6	35.5	47	6.6	58	—	50	10	—	10	—	12	44	4 × 1.9	3.00	—	—	—	M6	K	0.06	17 900	44 600	20 × 20

Ball return systems (details > page 9)



Single-thread ball return
Type ...I



Tube ball return
Type ...R



End cap ball return
Type ...E / ...F

Legend

- d₀ = nominal screw diameter [mm]
- d₁ = outer screw diameter [mm]
- d₂ = core diameter [mm]
- p = pitch [mm]

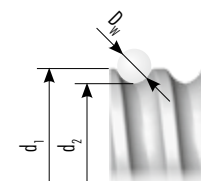

- i = number of ball circulations [—]
- D_w = ball diameter [mm]
- B = pin wrench hole* [mm]
- S = lubrication hole* [mm]
- SA = wipers (details > page 9)
- K = technopolymer wipers
- B = brush wipers
- F = felt rings (on request)

- T_{max} = max. standard backlash [mm]
- ³⁾ = only on request
- * position not defined
- Special designs available on request

⚠ When selecting a ballscrew, always observe the maximum rotational speed dependent on the system-specific rotational speed characteristics!
Calculation > page 12

> CAD data > www.gewinde.ch



ø25

Cylindrical nut

ZY...

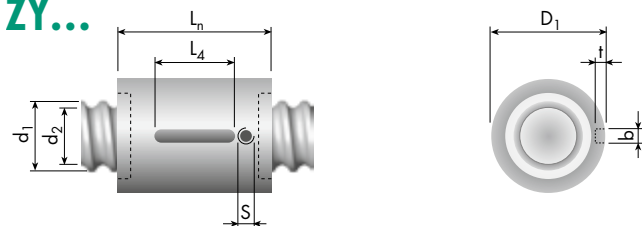

Nut with mounting thread

FG...

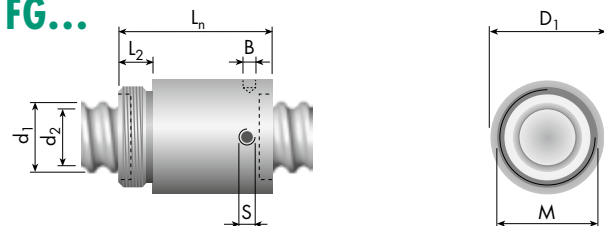

Flange nut

FB...

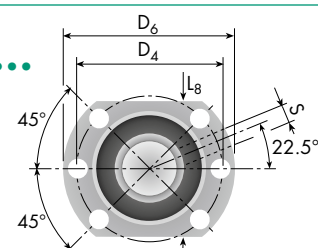

FA...

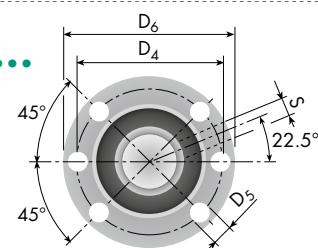

Nominal size d ₀ × p [mm]	Ball return Type	Relative cost	Right-/ left-hand thread	Dimensions [mm]																				Load rates [N]		Nominal size d ₀ × p [mm]			
				Screw										Nut										C _{dyn}	C _{stat}				
				d ₁	d ₂	D ₁	D ₂	D ₄ TK	D ₅ H13	D ₆ h13	M	L _n	L ₁	L ₂	L ₃	L ₄	L ₇	L ₈ h13	i	D _w	B +0.5/0	b P9	t	S	SA	T _{max}			
25 × 5	...I	€€€	RH / -	24.6	21.5	38 g6	-	-	-	-	-	50	-	-	-	20	-	-	3 × 1	3.50	-	4	2.5	M5	K	0.07	11 700	30 000	25 × 5
25 × 25	...E	€€€	RH / -	24.5	21.2	40 g6	-	-	-	-	-	60	-	-	-	20	-	-	4 × 1.9	3.50	-	4	2.5	ø 4	K	0.06	23 300	68 000	25 × 25
25 × 5	...I	€€	RH / -	24.6	21.5	40 0/-0.1	-	-	-	-	M38 × 1.5	57	-	12	-	-	-	-	3 × 1	3.50	4.0	-	-	M5	K	0.07	11 700	30 000	25 × 5
25 × 5	...R	€€	RH / -	24.6	21.5	44 0/-0.1	-	-	-	-	M40 × 1.5	58	-	19	-	-	-	-	2 × 2.5	3.50	4.0	-	-	-	-	0.07	17 500	42 400	25 × 5
25 × 10	...R	€€	RH / -	24.8	21.8	43 0/-0.1	-	-	-	-	M40 × 1.5	58	-	19	-	-	-	-	2 × 2.5	3.50	4.0	-	-	-	-	0.07	21 000	54 000	25 × 10
25 × 10	...R	€€	RH / -	24.8	21.8	43 0/-0.1	-	-	-	-	M40 × 1.5	58	-	19	-	-	-	-	2 × 2.5	3.50	4.0	-	-	ø 4	B	0.07	21 000	54 000	25 × 10
25 × 10	...F	€	RH / -	24.9	22.3	49 0/-0.1	-	-	-	-	M45 × 1.5	52	-	19	-	-	-	-	2 × 2.7	3.00	4.0	-	-	ø 4	K	0.07	14 100	39 800	25 × 10
25 × 25	...R	€€	RH / -	24.5	21.2	44 0/-0.1	-	-	-	-	M40 × 1.5	72	-	20	-	-	-	-	2 × 1.5	3.50	4.0	-	-	ø 4	B	0.08	10 000	24 000	25 × 25
25 × 25	...R	€€	RH / -	24.5	21.2	44 0/-0.1	-	-	-	-	M40 × 1.5	72	-	20	-	-	-	-	4 × 1.5	3.50	4.0	-	-	ø 4	B	0.08	20 000	48 000	25 × 25
25 × 5	...I	€€€	RH / -	24.6	21.5	40 g6	39.5	51	6.6	62	-	50	10	-	-	-	10	48	3 × 1	3.50	-	-	-	M6	K	0.07	11 700	30 000	25 × 5
25 × 5	...I	€€€	RH / -	24.6	21.5	40 g6	39.5	51	6.6	62	-	55	10	-	-	-	10	48	4 × 1	3.50	-	-	-	M6	K	0.07	14 000	35 000	25 × 5
25 × 10	...R	€€€	RH / -	24.8	21.8	43 g6	42.5	55	6.6	65	-	55	7	-	-	-	10	50	2 × 2.5	3.50	-	-	-	M6	B	0.07	21 000	54 000	25 × 10
25 × 25	...R	€€€	RH / -	24.5	21.2	44 g6	43.5	56	6.6	70	-	67	10	-	-	-	12	52	2 × 1.5	3.50	-	-	-	M6	B	0.08	10 000	24 000	25 × 25
25 × 25	...R	€€€	RH / -	24.5	21.2	44 g6	43.5	56	6.6	70	-	67	10	-	-	-	12	52	4 × 1.5	3.50	-	-	-	M6	B	0.08	20 000	48 000	25 × 25
25 × 25	...E	€€	RH / -	24.5	21.2	40 g6	39.8	51	6.6	62	-	60	10	-	10	-	10	48	4 × 1.9	3.50	-	-	-	ø 4	K	0.06	23 300	68 000	25 × 25
25 × 30	...E	€€	RH / -	24.8	21.5	40 g6	39.8	51	6.6	62	-	70	10	-	10	-	10	48	4 × 1.9	3.50	-	-	-	ø 4	K	0.06	23 000	67 800	25 × 30
25 × 10	...F	€€	RH / -	24.9	22.3	42 -0.01/-0.08	41.5	53	6.6	64	-	52	10	-	10	-	10	-	2 × 2.7	3.00	-	-	-	ø 4	K	0.07	14 100	39 800	25 × 10

Ball return systems (details > page 9)

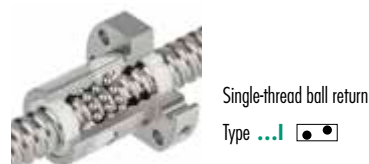

Legend

- d₀ = nominal screw diameter [mm]
- d₁ = outer screw diameter [mm]
- d₂ = core diameter [mm]
- p = pitch [mm]

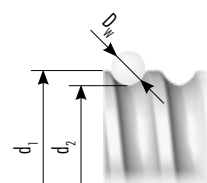

- i = number of ball circulations [-]
- D_w = ball diameter [mm]
- B = pin wrench hole* [mm]
- S = lubrication hole* [mm]
- SA = wipers (details > page 9)
- K = technopolymer wipers
- B = brush wipers
- F = felt rings (on request)

- T_{max} = max. standard backlash [mm]
- ³⁾ = only on request
- * position not defined
- Special designs available on request

⚠ When selecting a ballscrew, always observe the maximum rotational speed dependent on the system-specific rotational speed characteristics!
Calculation > page 12

> CAD data > www.gewinde.ch



ø32

Cylindrical nut

ZY...

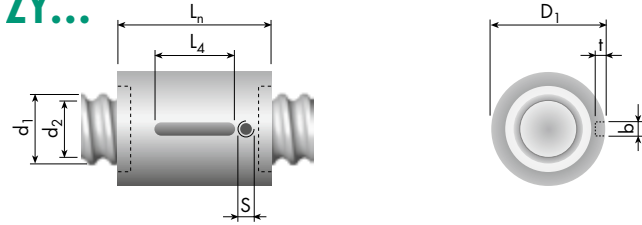

Nut with mounting thread

FG...

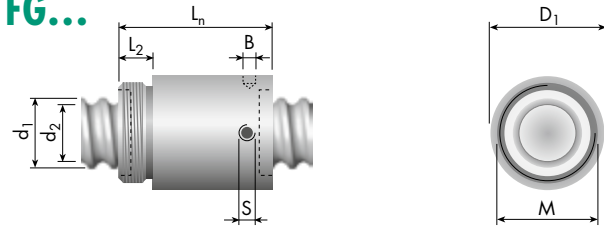

Flange nut

FB...

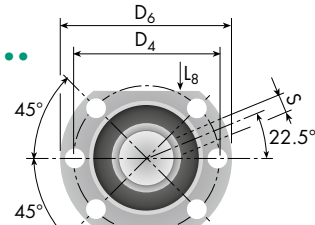

FA...

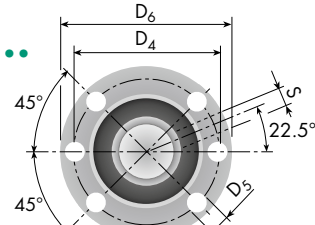

Nominal size d ₀ × p [mm]	Ball return Type	Relative cost	Right-/ left-hand thread	Dimensions [mm]																				Load rates [N]		Nominal size d ₀ × p [mm]			
				Screw										Nut										C _{dyn}	C _{stat}				
				d ₁	d ₂	D ₁	D ₂	D ₄ TK	D ₅ H13	D ₆ h13	M	L _n	L ₁	L ₂	L ₃	L ₄	L ₇	L ₈ h13	i	D _w	B +0.5/0	b P9	t	S	SA	T _{max}			
32 × 5	...I	€€€	RH / -	31.6	28.5	48 g6	-	-	-	-	-	48	-	-	-	20	-	-	4 × 1	3.50	-	5	3.0	M5	K	0.07	19 000	54 000	32 × 5
32 × 5	...I	€€	RH / -	31.6	28.5	52 0/-0.1	-	-	-	-	M48 × 1.5	55	-	15	-	-	-	-	4 × 1	3.50	4.0	-	-	M5	K	0.07	19 000	54 000	32 × 5
32 × 10	...R	€€	RH / -	31.6	28.4	52 0/-0.1	-	-	-	-	M48 × 1.5	62	-	19	-	-	-	-	2 × 2.5	3.50	4.0	-	-	ø 4	B	0.07	20 000	55 000	32 × 10
32 × 5	...I	€€€	RH / -	31.6	28.5	50 g6	49.5	65	9.0	80	-	57	10	-	-	-	12	62	4 × 1	3.50	-	-	-	M6	K	0.07	19 000	54 000	32 × 5
32 × 10	...R	€€€	RH / -	31.6	28.4	52 g6	51.5	67	9.0	82	-	62	10	-	-	-	12	64	2 × 2.5	3.50	-	-	-	M6	B	0.07	20 000	55 000	32 × 10
32 × 15	...R	€€€	RH / -	31.4	28.5	56 g6	55.5	71	9.0	86	-	74	12	-	-	-	14	65	2 × 2.5	3.50	-	-	-	M6	B	0.07	19 900	55 100	32 × 15
32 × 32	...R	€€€	RH / -	31.5	28.5	56 g6	55.5	71	9.0	86	-	86	12	-	-	-	14	65	4 × 1.5	3.50	-	-	-	M6	B	0.07	25 700	76 200	32 × 32

Ball return systems (details > page 9)



Single-thread ball return
Type ...I



Tube ball return
Type ...R



End cap ball return
Type ...E / ...F

Legend

- d₀ = nominal screw diameter [mm]
- d₁ = outer screw diameter [mm]
- d₂ = core diameter [mm]
- p = pitch [mm]

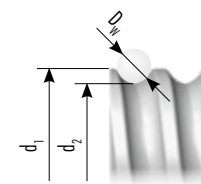

- i = number of ball circulations [-]
- D_w = ball diameter [mm]
- B = pin wrench hole* [mm]
- S = lubrication hole* [mm]

- SA = wipers (details > page 9)
- K = technopolymer wipers
- B = brush wipers
- F = felt rings (on request)

- T_{max} = max. standard backlash [mm]
- ³⁾ = only on request
- * position not defined
- Special designs available on request

When selecting a ballscrew, always observe the maximum rotational speed dependent on the system-specific rotational speed characteristics!
Calculation > page 12

> CAD data > www.gewinde.ch



ø 40

Cylindrical nut

ZY...

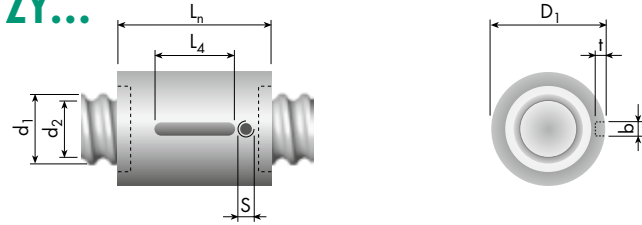

Nut with mounting thread

FG...

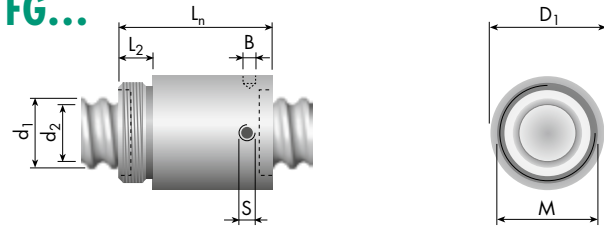

Flange nut

FB...

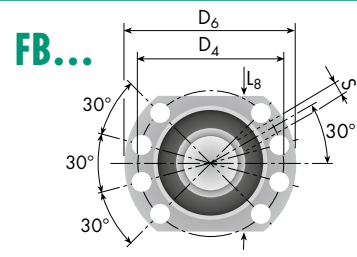

FA...

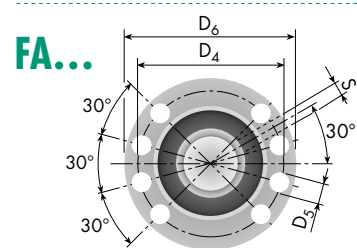

Nominal size d ₀ × p [mm]	Ball return Type	Relative cost	Right-/ left-hand thread	Dimensions [mm]																				Load rates [N]		Nominal size d ₀ × p [mm]			
				Screw										Nut										C _{dyn}	C _{stat}				
				d ₁	d ₂	D ₁	D ₂	D ₄ TK	D ₅ H13	D ₆ h13	M	L _n	L ₁	L ₂	L ₃	L ₄	L ₇	L ₈ h13	i	D _w	B +0.5/0	b P9	t	S	SA	T _{max}			
40 × 5	...R	€€€	RH / —	39.8	36.9	65 g6	64.5	78	9.0	93	—	75	12	—	—	—	14	70	2 × 3.5	3.50	—	—	—	M8 × 1	B	0.07	29 400	97 000	40 × 5
40 × 20	...R	€€€	RH / —	40.3	36.9	65 g6	64.7	78	9.0	93	—	88	12	—	—	—	14	70	2 × 2.5	4.00	—	—	—	M8 × 1	B	0.07	25 500	77 400	40 × 20
40 × 40	...R	€€€	RH / —	39.8	36.4	66 g6	65.5	80	9.0	95	—	98	12	—	—	—	14	75	4 × 1.5	4.00	—	—	—	M8 × 1	B	0.07	29 900	94 500	40 × 40
40 × 40	...F	€€	RH / —	39.8	36.4	62 ^{-0.01/-0.09}	61.5	78	9.0	93	—	90	12	—	12	—	12	—	4 × 1.7	4.00	—	—	—	ø 4	K	0.07	30 600	108 100	40 × 40

> CAD data > www.gewinde.ch

Ball return systems (details > page 9)



Single-thread ball return
Type ...I



Tube ball return
Type ...R



End cap ball return
Type ...E / ...F

Legend

- d₀ = nominal screw diameter [mm]
- d₁ = outer screw diameter [mm]
- d₂ = core diameter [mm]
- p = pitch [mm]

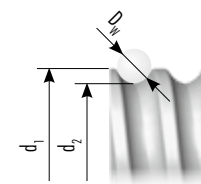

- i = number of ball circulations [-]
- D_w = ball diameter [mm]
- B = pin wrench hole* [mm]
- S = lubrication hole* [mm]
- SA = wipers (details > page 9)
- K = technopolymer wipers
- B = brush wipers
- F = felt rings (on request)

- T_{max} = max. standard backlash [mm]
- ³⁾ = only on request
- * position not defined
- Special designs available on request

⚠ When selecting a ballscrew, always observe the maximum rotational speed dependent on the system-specific rotational speed characteristics!
Calculation > page 12

Speedy high-helix leadscrews (SGS)

100% Swiss made

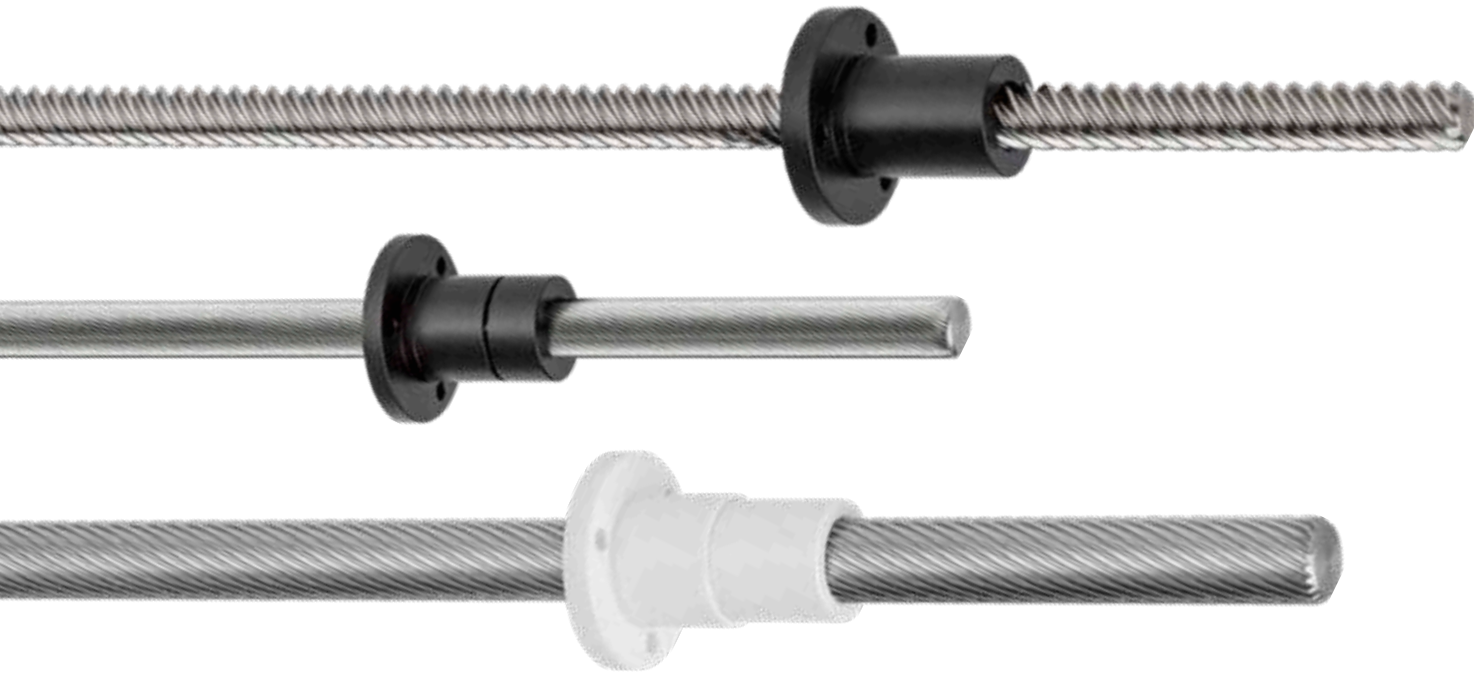

Design features

Eichenberger high-helix leadscrews are called Speedy for good reason: never before have such high moving speeds been obtained at such low rotational speeds. The Eichenberger Speedy has made this possible by using a helix pitch unheard of before.

High-helix leadscrews are made of corrosion-protected steel and are formed by the cold-rolling process. They are coupled with high wear-resistant technopolymer flange nuts in non-preloaded or preloaded designs.

For higher loads or special applications, alternative technopolymer materials or bronze may be used to make the nuts.

Materials

Screw

- standard: corrosion-protected steel
 - 1.4021 (X20Cr13)
- on request: other materials such as
 - corrosion and acid resistant steel 1.4404 (X2CrNiMo17-12-2)
 - aluminium
- on request:
 - coating to reduce sliding friction

Nut

- non-preloaded:
 - POM-C black
 - bronze 2.1052 (CuSn12)
- preloaded:
 - axial-preloaded (if $p_0 < d_0$): POM-C black
 - torsion-preloaded (if $p_0 \geq d_0$): EX100 white
 - bronze on request
- on request: other materials such as
 - iglidur® J *

* iglidur® is a registered trademark of igus® GmbH

Speedy high-helix leadscrews – design features

Nut types (shapes)

For all Speedy high-helix leadscrews one standard flange nut design has been defined (flange nut type A following DIN 69051), which is deliverable in the following types:



- Flange nut, non-preloaded
- **Type SFM:** POM-C black
 - **Type SBM:** bronze



- Flange nut axial-preloaded (if $p_0 < d_0$)
- **Type SFV:** POM-C black
 - on request:
 - nut body made of bronze



- Flange nut torsion-preloaded (if $p_0 \geq d_0$)
- **Type SFT:** EX100 white
 - on request:
 - nut body made of bronze

If required, any application-specific nut shapes can be manufactured, for large series also from injection molding. Contact us with your revolutionary idea – we'll provide YOUR tailor-made high-helix leadscrew!

Operational temperatures

- POM-C / EX100 –40 to +60 °C
- iglidur® J –50 to +90 °C
- bronze –40 to +200 °C

Lead accuracy

- standard:
 - $G9 \triangleq \leq 0.1$ mm/300 mm (in accordance with DIN 69051)
- on request:
 - other lead accuracies

Efficiency

The efficiency η depends on the helix angle and reaches values from ~0.5 to 0.75

> also see diagram, page 44

Production / Handling / Lubrication

Production lengths

In general, Eichenberger screws are produced as bars with a length of 3 m. Depending on the diameter and the material availability, lengths up to 6 m are also possible on request.

Any kind of end machining

By default leadscrews are cut to the desired length without special machining.

Upon request, a so-called standard screw end journal with three turned bearing seats is available. Dimensions are as per customer specifications. Note also the links to the CAD data at www.gewinde.ch

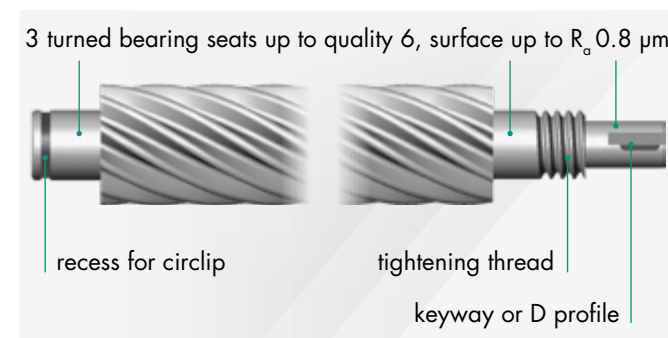

Our speciality is any application-specific end machining: Tell us your requirements, and we'll provide YOUR tailor-made screw!

In each instance, a detailed drawing would be necessary.

Handling

Speedy, Easy and Rondo leadscrews are precision parts and must be protected from shock, dirt or moisture when transported or stored. Please do not unpack until ready for use.

Please check for cleanness when mounting a leadscrew. Dirt or foreign matter on the thread may cause increased wear and premature failure.

Please consult lubrication recommendation before mounting or operating leadscrews.

Radial loads and torque

Radial loads or torque brought to bear upon the nut result in overload of individual contact surfaces, thus seriously affecting the service life of the leadscrew assembly. Therefore it is important to properly mount the screw and to comply with all relevant form and positional tolerances.

Lubrication

In some cases, a single lubrication with grease or oil is sufficient. However, any lubrication cycle depends on the application environment.

Bronze nuts have to be lubricated regularly.

Recommended all-purpose lubricant:

- Klüber Microlube GBU Y 131

Surface coatings

... possible on request:

- generally to reduce sliding friction
- if lubrication is not possible (e.g. in the food industry)

> also see Materials, page 40

Application examples for Eichenberger leadscrews

Eichenberger Speedy, Easy and Rondo leadscrews are suitable for numerous applications: On the one hand, for shorter lifts, they are a great substitute for belt drive systems because of their lower engineering effort. On the other hand, they are also an excellent substitute for hydraulic and pneumatic lift cylinders because they can be freely accelerated and positioned, and work independently of secondary energy sources. Thanks to high efficiency and excellent value for money, they are an ideal alternative to trapezoidal screws or ballscrews in particular areas of use.

Typical areas of application:

- Drives for doors, gates and windows
- Air-conditioning technology (valve/slide drives)
- Construction industry (e.g. automatic shading systems)
- Handling systems
- Graphics equipment and devices
- Medical technology
- Textile machines
- Food and packaging industry
- Electric cylinders (actuators)
- Electronics industry



Rondo: Pressing of freshly ground coffee in a modern gastro coffee machine



Speedy: Automatic shading systems for modern glass façades



Easy: Door drives in train carriages

Design fundamentals

The following are the relevant calculations which underlie screw design and safe operation of a Speedy, Easy or Rondo leadscrew.

Calculations at dynamic load:

Critical rotational speed n_{per}

Permissible rotational speeds must differ substantially from the screw's own frequency.

$$n_{per} = K_D \cdot 10^6 \cdot \frac{d_2}{l_a^2} \cdot S_n \quad [\text{min}^{-1}]$$

n_{per} = permissible rotational speed [min^{-1}]

K_D = characteristic constant [-]

as a function of bearing configuration > see aside

d_2 = core screw diameter [mm]

l_a = bearing distances [mm] > see aside

(always include maximum allowable l_a in calculation!)

S_n = safety factor [-], usually $S_n = 0.5 \dots 0.8$

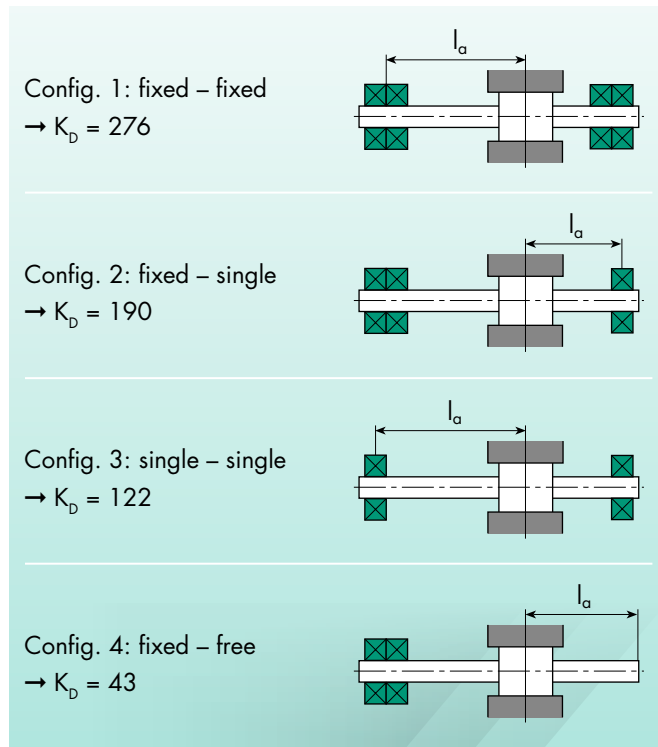

Efficiency η_p (practical)

The efficiency η depends on the helix angle and reaches the following values:

- **Speedy** ~0.5...0.75
- **Easy** >0.8
- **Rondo** ~0.3...0.5

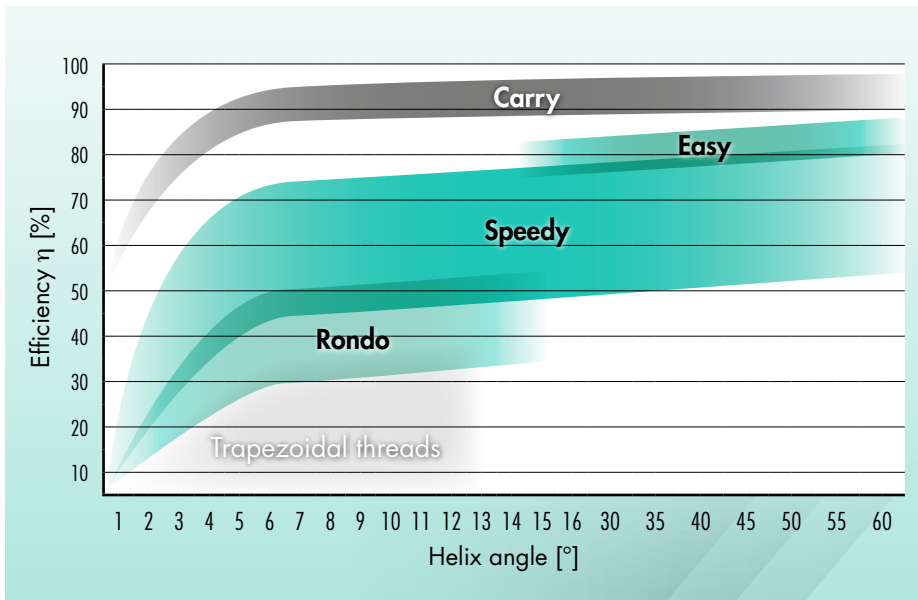

Driving torque M

depends upon the type of power transmission

- Case 1: torque → linear movement

$$M_o = \frac{F_a \cdot p}{2000 \cdot \pi \cdot \eta} \quad [\text{Nm}]$$

- Case 2: axial force → torque

$$M_o = \frac{F_a \cdot p \cdot \eta'}{2000 \cdot \pi} \quad [\text{Nm}]$$

M_o = input torque [Nm], case 1

M_o = output torque [Nm], case 2

F_a = axial force [N]

p = pitch [mm]

η = efficiency [%]

η' = corrected efficiency [%]

Input performance P

$$P = \frac{M_o \cdot n}{9550} \quad [\text{kW}]$$

P = input performance [kW]

n = rotational speed [min^{-1}]

A safety margin of 20% is recommended when selecting drives.

Basic calculations

Maximum authorized load depending on speed

$$F_{per.} = C_o \cdot f_L \quad [\text{N}]$$

C_o = static load rate [N]

f_L = load factor [-] for POM-C nuts

Circumferential speed v_c [m/min]	Load factor f_L [-]
5	0.95
10	0.75
20	0.45
30	0.37
40	0.12
50	0.08

Example

- Parameters:

Speedy 10/50 with non-preloaded POM-C nut, $d_o = 10$ mm, $p = 50$ mm and $C_o = 1250$ N; required moving speed $v_s = 200$ mm/sec.

- We need to find: $F_{per.}$

Therefore we calculate n [min^{-1}],

$$n = \frac{v_s \text{ [mm/sec.]} \cdot 60}{p \text{ [mm]}} = \frac{200 \cdot 60}{50} = 240 \text{ min}^{-1}$$

the circumferential speed v_c [m/min]

$$v_c = \frac{d_o \text{ [mm]} \cdot \pi \cdot n \text{ [min}^{-1}\text{]}}{1000} = \frac{10 \cdot \pi \cdot 240}{1000} = 7.53 \text{ m/min}$$

and find the load factor f_L in above table:

$$f_L \text{ at } v_c \text{ of } 7.53 \text{ m/min} \approx 0.85 \text{ [-]}$$

- It follows:

$$F_{per.} = C_{stat} \cdot f_L = 1250 \cdot 0.85 = 1062.5 \text{ N}$$

So the maximum load for a Speedy 10/50 at $v_s = 200$ mm/sec. ($\rightarrow n = 240 \text{ min}^{-1}$) is 1060 N.



Order system – Speedy high-helix leadscrews

Example for complete Speedy high-helix leadscrew _____ **SGS 18/100 SFM RH 350 G9 E M**

Type of thread drive _____
 SGS = Speedy high-helix leadscrews

Nominal size (d₀ / p₀) [mm] _____
 for nut only

Nut type _____
 SFM = standard flange nut, non-preloaded (POM-C black) ¹⁾
 SBM = standard flange nut, non-preloaded, made of bronze
 SFV = standard flange nut, axial-preloaded (p₀ < d₀; POM-C black) ^{1) 2)}
 SFT = standard flange nut, torsion-preloaded (p₀ ≥ d₀; EX100 white) ^{1) 2)}
 MSX = special design according to drawing

Right-hand / left-hand thread _____
 RH = right-hand thread (standard)
 LH = left-hand thread (availability see dimensional charts)

Leadscrew overall length [mm] _____
 standard quality: 1.4021 (X20Cr13) ¹⁾
 for screw only

Lead accuracy (class) _____
 G9 = ≤0.1 mm/300 mm (standard)
 GX = lead accuracy upon specification
 for screw only

Screw end machining _____
 O = no end machining (cut by grinding)
 E = end machining according to drawing
 for screw only

Assembly _____
 G = screw and nut separate (standard)
 M = screw and nut assembled according to drawing/specified orientation

¹⁾ other materials on request
²⁾ bronze on request

Example for screw only _____ **SGS 18/100 RH 350 G9 O G**

Example for nut only _____ **SGS 18/100 SFM RH G**

Dimension map – Speedy standard range

d ₀ / p ₀ [mm]	Nominal diameter d ₀ [mm]																																						
	4	4.96	5	6	6.35	7.5	7.94	8	9	9.7	10	11	11.2	12	12.5	12.8	13	14	14.3	15	16	17.6	18	19	20	21	22	23	24	25.7	26	27	28	30	32	34	36		
4																																							
5																																							
6.35																																							
7.5																																							
8																																							
10																																							
12																																							
12.5																																							
12.7																																							
15																																							
16																																							
16.25																																							
18																																							
20																																							
21																																							
24																																							
25																																							
25.4																																							
27																																							
28																																							
30																																							
30.5																																							
32																																							
35																																							
35.6																																							
38																																							
40																																							
40.6																																							
45																																							
45.7																																							
50																																							
50.8																																							
55																																							
60																																							
65																																							
70																																							
75																																							
76.2																																							
80																																							
90																																							
96.5																																							
100																																							
120																																							
200																																							
Register	ø 4 ... 9.7					ø 10 ... 13					ø 14 ... 17.6					ø 18 ... 25.7					ø 26 ... 36																		
Pages	48/49					50/51					52/53					54/55					56/57																		



ø4...9.7

Standard flange nut non-preloaded / preloaded

Non-preloaded:

SFM POM-C black

SBM bronze

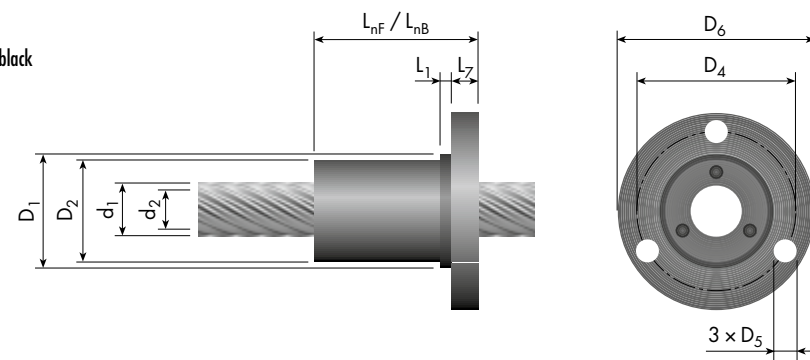

Axial-preloaded, if $p_0 < d_0$:

SFV POM-C black

(bronze on request)

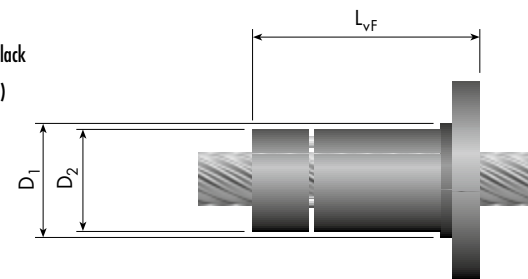

Torsion-preloaded, if $p_0 \geq d_0$:

SFT EX100 white

(bronze on request)

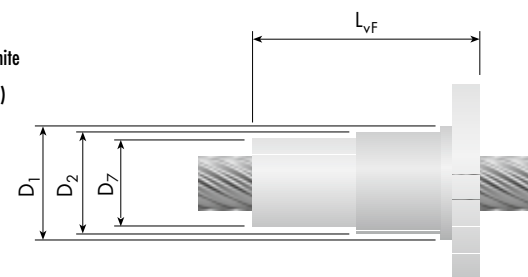

Nominal size d_0/p_0 [mm] (in)	Right-hand/ left-hand thread	Dimensions [mm]															Load rates for POM-C/EX100 C_{stat} [N]	Nominal size d_0/p_0 [mm] (in)
		Screw				Nut												
		d_1	d_2	p	g	$D_{1\text{th}}$	$D_{2\pm 0.05}$	$D_{4\text{TK}}$	D_5	D_6	D_7	L_{nF}	L_{nB}	L_{vF}	L_1	L_2		
4 / 10	RH / —	4.0	3.0	10	8	12	11.5	18	3.2	28	—	20	15	—	3	4	150	4 / 10
4.96 / 16.25	RH / —	5.0	4.0	16.25	13	12	11.5	18	3.2	28	—	20	15	—	3	4	220	4.96 / 16.25
5 / 5	RH / —	5.4	3.6	5	4	21	20.5	29	4.2	38	18.5	25	18	38	3	5	300	5 / 5
5 / 20	RH / LH	6.0	5.0	20	16	21	20.5	29	4.2	38	18.5	25	18	38	3	5	300	5 / 20
6 / 25	RH / —	7.4	6.3	25	20	21	20.5	29	4.2	38	18.5	25	18	38	3	5	400	6 / 25
6.35 / 6.35 (1/4"/1/4")	RH / —	6.4	4.4	6.35	4	21	20.5	29	4.2	38	18.5	25	18	38	3	5	850	6.35 / 6.35 (1/4"/1/4")
6.35 / 12.7 (1/4"/1/2")	RH / —	6.3	4.6	12.70	6	21	20.5	29	4.2	38	18.5	25	18	38	3	5	800	6.35 / 12.7 (1/4"/1/2")
6.35 / 25.4 (1/4"/1")	RH / —	6.35	4.2	25.40	8	21	20.5	29	4.2	38	18.5	25	18	38	3	5	800	6.35 / 25.4 (1/4"/1")
6.35 / 25.4 (1/4"/1")	RH / —	6.1	4.4	25.40	10	21	20.5	29	4.2	38	18.5	25	18	38	3	5	700	6.35 / 25.4 (1/4"/1")
7.5 / 7.5	RH / —	7.7	5.9	7.5	6	21	20.5	29	4.2	38	18.5	25	18	38	3	5	450	7.5 / 7.5
7.94 / 12.7 (5/16"/1/2")	RH / —	7.9	5.8	12.70	6	21	20.5	29	4.2	38	18.5	25	18	38	3	5	1100	7.94 / 12.7 (5/16"/1/2")
8 / 4	RH / —	7.9	5.5	4	2	24	23.5	32	4.2	42	—	25	18	38	3	5	950	8 / 4
8 / 10	RH / LH	8.2	5.5	10	4	24	23.5	32	4.2	42	21.5	25	18	38	3	5	800	8 / 10
8 / 12	RH / —	8.0	5.9	12	5	24	23.5	32	4.2	42	21.5	25	18	38	3	5	800	8 / 12
8 / 15	RH / —	8.0	5.9	15	6	24	23.5	32	4.2	42	21.5	25	18	38	3	5	850	8 / 15
8 / 30	RH / LH	8.6	7.5	30	24	21	20.5	29	4.2	38	18.5	25	18	38	3	5	500	8 / 30
8 / 38	RH / —	8.0	5.7	38	8	24	23.5	32	4.2	42	21.5	25	18	38	3	5	1000	8 / 38
9 / 20	RH / —	8.9	5.8	20	5	24	23.5	32	4.2	42	21.5	25	18	38	3	5	850	9 / 20
9.7 / 25.4 (3/8"/1")	RH / LH	9.7	6.4	25.40	5	24	23.5	32	4.2	42	21.5	25	—	38	3	5	1200	9.7 / 25.4 (3/8"/1")

ø4...9.7

Nut types (details > page 41)



Legend

d_0 = Nominal screw diameter [mm]
 d_1 = outer screw diameter [mm]
 d_2 = core diameter [mm]

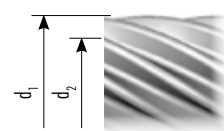

p_0 = nominal pitch [mm]
 p = effective pitch [mm]
 g = number of threads [—]

L_{nF} = length of nut body, non-preloaded, POM-C (type SFM)
 L_{nB} = length of nut body, non-preloaded, bronze (type SBM)
 L_{vF} = length of nut body, preloaded, POM-C/EX100 (types SFV and SFT)

C_{stat} = static load rates for non-preloaded and preloaded nuts made of POM-C / EX100 [N];
 for higher load rates → bronze nuts → $C_{stat\text{bronze}} = 1.3 \times C_{stat\text{POM-C/EX100}}$
³⁾ = only on request
 Special designs available on request

> CAD data > www.gewinde.ch



ø 10...13

Standard flange nut non-preloaded / preloaded

Non-preloaded:

SFM POM-C black

SBM bronze

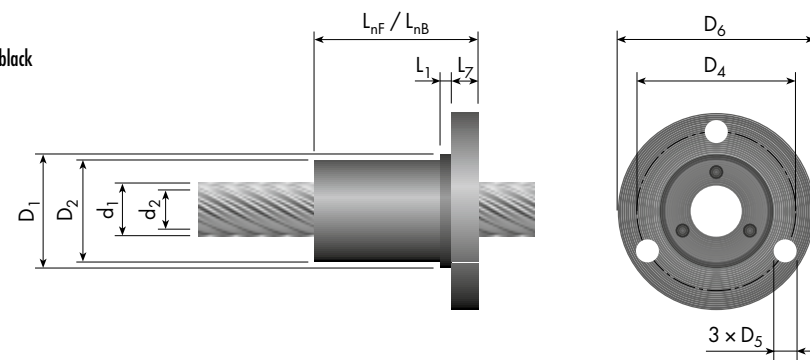

Axial-preloaded, if $p_0 < d_0$:

SFV POM-C black

(bronze on request)

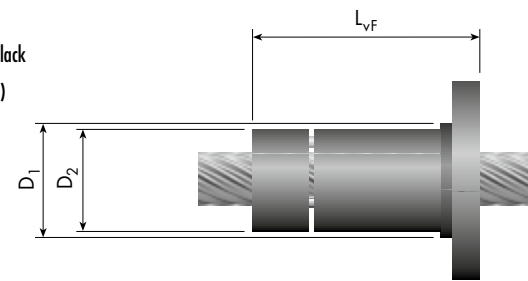

Torsion-preloaded, if $p_0 \geq d_0$:

SFT EX100 white

(bronze on request)

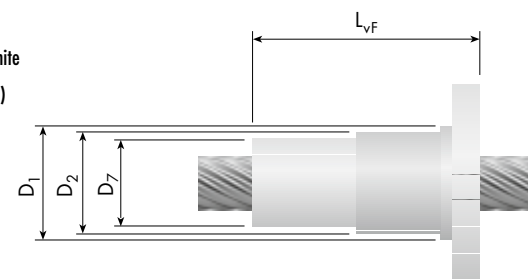

Nominal size d_0 / p_0 [mm] (in)	Right-hand/ left-hand thread	Dimensions [mm]															Load rates for POM-C/EX100 C_{stat} [N]	Nominal size d_0 / p_0 [mm] (in)
		Screw				Nut												
		d_1	d_2	p	g	$D_{1\text{H8}}$	$D_{2\pm 0.05}$	$D_{4\text{TK}}$	D_5	D_6	D_7	L_{nF}	L_{nB}	L_{vF}	L_1	L_2		
10 / 10	RH / —	10.0	8.2	10	8	24	23.5	32	4.2	42	21.5	25	18	38	3	5	600	10 / 10
10 / 12	RH / LH	10.0	7.1	12	4	24	23.5	32	4.2	42	21.5	25	18	38	3	5	1 200	10 / 12
10 / 15	RH / —	10.0	7.4	15	5	24	23.5	32	4.2	42	21.5	25	18	38	3	5	1 200	10 / 15
10 / 35	RH / LH	10.1	8.9	35	28	24	23.5	32	4.2	42	21.5	25	18	38	3	5	600	10 / 35
10 / 50	RH / LH	10.0	7.4	50	10	26	25.5	36	5.1	46	23.5	42	30	58	3	7	1 250	10 / 50
11 / 40	RH / —	11.5	10.2	40	32	24	23.5	32	4.2	42	21.5	25	18	38	3	5	700	11 / 40
11 / 60	RH / —	11.7	9.1	60	12	26	25.5	36	5.1	46	23.5	42	30	58	3	7	1 500	11 / 60
11.2 / 30.5 (7/16"/1 3/16")	RH / —	11.2	8.0	30.48	6	24	23.5	32	4.2	42	21.5	25	18	38	3	5	1 400	11.2 / 30.5 (7/16"/1 3/16")
12 / 15	RH / LH	12.2	9.2	15	5	24	23.5	32	4.2	42	21.5	25	18	38	3	5	1 400	12 / 15
12 / 25	RH / LH	11.9	8.0	25	5	24	23.5	32	4.2	42	21.5	25	18	38	3	5	1 500	12 / 25
12 / 45	RH / LH	12.8	11.4	45	36	24	23.5	32	4.2	42	21.5	25	18	38	3	5	800	12 / 45
12.5 / 12.5 ³⁾	RH / —	12.3	10.4	12.5	10	24	23.5	32	4.2	42	21.5	25	18	38	3	5	750	12.5 / 12.5 ³⁾
12.8 / 35.6 (1/2"/1 3/16")	RH / —	12.8	9.6	35.56	7	24	23.5	32	4.2	42	21.5	25	18	38	3	5	1 600	12.8 / 35.6 (1/2"/1 3/16")
13 / 20	RH / —	13.3	8.8	20	4	26	25.5	36	5.1	46	23.5	42	30	58	3	7	1 300	13 / 20
13 / 70	RH / LH	13.5	10.9	70	14	26	25.5	36	5.1	46	23.5	42	30	58	3	7	1 750	13 / 70

ø 10...13

Nut types (details > page 41)



Legend

d_0 = Nominal screw diameter [mm]
 d_1 = outer screw diameter [mm]
 d_2 = core diameter [mm]

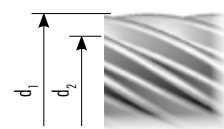

p_0 = nominal pitch [mm]
 p = effective pitch [mm]
 g = number of threads [—]

L_{nF} = length of nut body, non-preloaded, POM-C (type SFM)
 L_{nB} = length of nut body, non-preloaded, bronze (type SBM)
 L_{vF} = length of nut body, preloaded, POM-C/EX100 (types SFV and SFT)

C_{stat} = static load rates for non-preloaded and preloaded nuts made of POM-C / EX100 [N];
 for higher load rates → bronze nuts → $C_{stat\text{ bronze}} = 1.3 \times C_{stat\text{ POM-C/EX100}}$
³⁾ = only on request

Special designs available on request

> CAD data > www.gewinde.ch



ø 14... 17.6

Standard flange nut non-preloaded / preloaded

Non-preloaded:

SFM POM-C black

SBM bronze

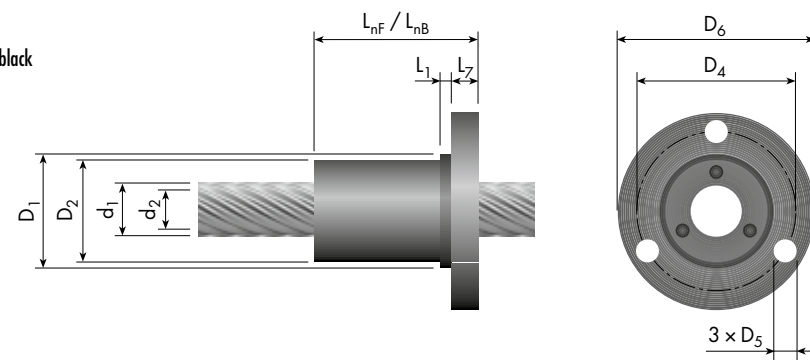

Axial-preloaded, if $p_0 < d_0$:

SFV POM-C black

(bronze on request)

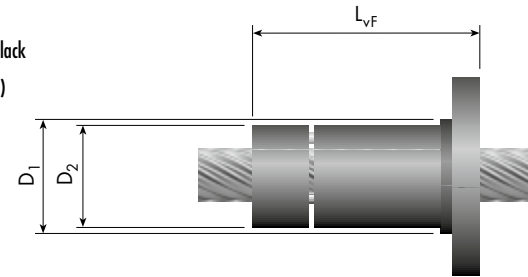

Torsion-preloaded, if $p_0 \geq d_0$:

SFT EX100 white

(bronze on request)

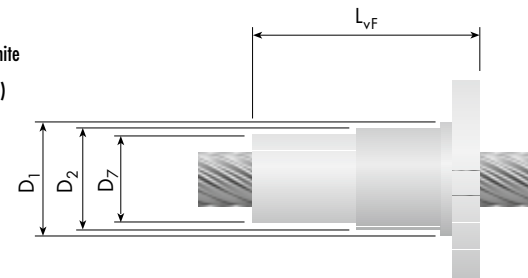

Nominal size d_0 / p_0 [mm] (in)	Right-hand/ left-hand thread	Dimensions [mm]																Load rates for POM-C/EX100 C_{stat} [N]	Nominal size d_0 / p_0 [mm] (in)
		Screw				Nut													
		d_1	d_2	p	g	$D_{1\text{H8}}$	$D_{2\pm 0.05}$	$D_{4\text{TK}}$	D_5	D_6	D_7	L_{nF}	L_{nB}	L_{vF}	L_1	L_2			
14 / 8	RH / —	14.0	9.8	8	2	26	25.5	36	5.1	46	—	42	30	58	3	7	900	14 / 8	
14 / 18	RH / LH	14.3	11.4	18	6	26	25.5	36	5.1	46	23.5	42	30	58	3	7	1600	14 / 18	
14 / 30	RH / LH	13.9	10.1	30	6	26	25.5	36	5.1	46	23.5	42	30	58	3	7	1750	14 / 30	
14 / 40	RH / —	14.0	10.9	40	5	26	25.5	36	5.1	46	23.5	42	30	58	3	7	1800	14 / 40	
14.3 / 40.6 (5/16" / 1 3/8")	RH / LH	14.4	11.2	40.64	8	26	25.5	36	5.1	46	23.5	42	30	58	3	7	1800	14.3 / 40.6 (5/16" / 1 3/8")	
15 / 20	RH / LH	15.2	12.5	20	8	30	29.5	39	5.1	49	27	42	30	58	3	7	1600	15 / 20	
15 / 80	RH / LH	15.2	12.6	80	16	30	29.5	39	5.1	49	27	42	30	58	3	7	2000	15 / 80	
16 / 21	RH / LH	16.5	13.6	21	7	30	29.5	39	5.1	49	27	42	30	58	3	7	1800	16 / 21	
16 / 25	RH / —	16.0	11.5	25	5	30	29.5	39	5.1	49	27	42	30	58	3	7	1550	16 / 25	
16 / 35	RH / —	15.9	12.1	35	7	30	29.5	39	5.1	49	27	42	30	58	3	7	2000	16 / 35	
16 / 45.7 ³⁾ (5/8" / 1 7/8")	RH / —	16.0	12.8	45.72	9	30	29.5	39	5.1	49	27	42	30	58	3	7	2000	16 / 45.7 ³⁾ (5/8" / 1 7/8")	
16 / 90	RH / LH	17.0	14.3	90	18	30	29.5	39	5.1	49	27	42	30	58	3	7	2250	16 / 90	
17.6 / 50.8 (7/8" / 2")	RH / —	17.6	14.4	50.80	10	30	29.5	39	5.1	49	27	42	30	58	3	7	2200	17.6 / 50.8 (7/8" / 2")	

ø 14... 17.6

> CAD data > www.gewinde.ch

Nut types (details > page 41)



Legend

d_0 = Nominal screw diameter [mm]
 d_1 = outer screw diameter [mm]
 d_2 = core diameter [mm]

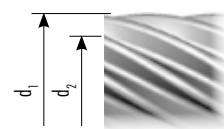

p_0 = nominal pitch [mm]
 p = effective pitch [mm]
 g = number of threads [-]

L_{nF} = length of nut body, non-preloaded, POM-C (type SFM)
 L_{nB} = length of nut body, non-preloaded, bronze (type SBM)
 L_{vF} = length of nut body, preloaded, POM-C/EX100 (types SFV and SFT)

C_{stat} = static load rates for non-preloaded and preloaded nuts made of POM-C / EX100 [N];
 for higher load rates → bronze nuts → $C_{stat\text{bronze}} = 1.3 \times C_{stat\text{POM-C/EX100}}$
³⁾ = only on request
 Special designs available on request



ø 18 ... 25.7

Standard flange nut non-preloaded / preloaded

Non-preloaded:

SFM POM-C black

SBM bronze

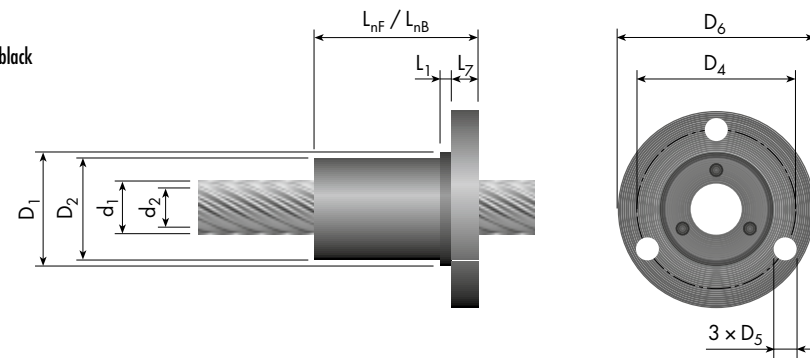

Axial-preloaded, if $p_0 < d_0$:

SFV POM-C black

(bronze on request)

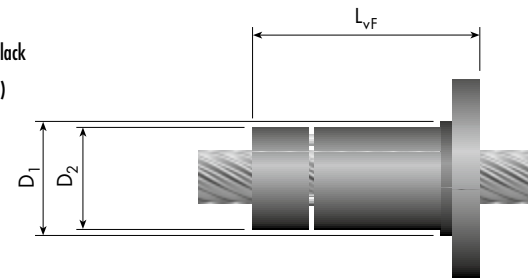

Torsion-preloaded, if $p_0 \geq d_0$:

SFT EX100 white

(bronze on request)

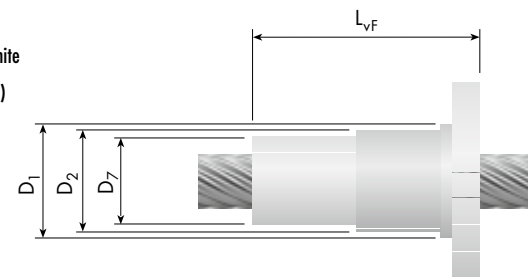

Nominal size d_0 / p_0 [mm] (in)	Right-hand/ left-hand thread	Dimensions [mm]																Load rates for POM-C/EX100 C_{stat} [N]	Nominal size d_0 / p_0 [mm] (in)
		Screw				Nut													
		d_1	d_2	p	g	$D_{1\text{H8}}$	$D_{2\pm 0.05}$	$D_{4\text{TK}}$	D_5	D_6	D_7	L_{nF}	L_{nB}	L_{vF}	L_1	L_2			
18 / 16	RH / —	18.0	14.3	16	4	30	29.5	39	5.1	49	—	42	30	58	3	7	1 100	18 / 16	
18 / 24	RH / LH	18.7	15.7	24	8	30	29.5	39	5.1	49	27	42	30	58	3	7	2 000	18 / 24	
18 / 40	RH / LH	17.9	14.1	40	8	30	29.5	39	5.1	49	27	42	30	58	3	7	2 250	18 / 40	
18 / 100	RH / LH	18.8	16.2	100	20	30	29.5	39	5.1	49	27	42	30	58	3	7	2 500	18 / 100	
19 / 30	RH / —	18.8	14.2	30	6	30	29.5	39	5.1	49	27	42	30	58	3	7	1 800	19 / 30	
20 / 12	RH / —	20.0	15.8	12	3	36	35.5	47	6.2	59	—	46	32	64	5	8	1 200	20 / 12	
20 / 45	RH / —	20.0	16.1	45	9	36	35.5	47	6.2	59	33	46	32	64	5	8	2 500	20 / 45	
21 / 27	RH / —	20.8	17.9	27	9	36	35.5	47	6.2	59	33	46	32	64	5	8	2 200	21 / 27	
21 / 35 ³⁾	RH / —	21.5	17.0	35	7	36	35.5	47	6.2	59	33	46	32	64	5	8	2 050	21 / 35 ³⁾	
22 / 20	RH / —	22.0	18.3	20	5	36	35.5	47	6.2	59	—	46	32	64	5	8	1 400	22 / 20	
22 / 50	RH / —	22.0	18.1	50	10	36	35.5	47	6.2	59	33	46	32	64	5	8	2 750	22 / 50	
22 / 120	RH / —	22.5	19.8	120	24	36	35.5	47	6.2	59	33	46	32	64	5	8	3 000	22 / 120	
23 / 30	RH / LH	23.0	20.0	30	10	36	35.5	47	6.2	59	33	46	32	64	5	8	2 400	23 / 30	
24 / 40 ³⁾	RH / —	24.3	19.8	40	8	36	35.5	47	6.2	59	33	46	32	64	5	8	2 300	24 / 40 ³⁾	
24 / 55	RH / —	24.0	20.1	55	11	36	35.5	47	6.2	59	33	46	32	64	5	8	3 000	24 / 55	
25.7 / 76.2 (1"/3")	RH / LH	25.7	24.0	76.20	15	42	41.5	53	6.2	64	39	50	35	71	5	8	2 800	25.7 / 76.2 (1"/3")	

Nut types (details > page 41)



Legend

d_0 = Nominal screw diameter [mm]
 d_1 = outer screw diameter [mm]
 d_2 = core diameter [mm]

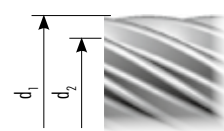

p_0 = nominal pitch [mm]
 p = effective pitch [mm]
 g = number of threads [—]

L_{nF} = length of nut body, non-preloaded, POM-C (type SFM)
 L_{nB} = length of nut body, non-preloaded, bronze (type SBM)
 L_{vF} = length of nut body, preloaded, POM-C/EX100 (types SFV and SFT)

C_{stat} = static load rates for non-preloaded and preloaded nuts made of POM-C / EX100 [N];
 for higher load rates → bronze nuts → $C_{stat\text{bronze}} = 1.3 \times C_{stat\text{POM-C/EX100}}$
³⁾ = only on request
 Special designs available on request

> CAD data > www.gewinde.ch



ø26 ... 36

Standard flange nut non-preloaded / preloaded

Non-preloaded:

SFM POM-C black

SBM bronze

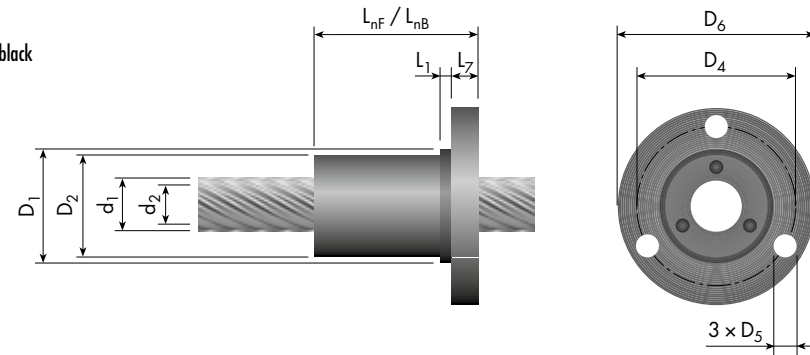

Axial-preloaded, if $p_0 < d_0$:

SFV POM-C black

(bronze on request)

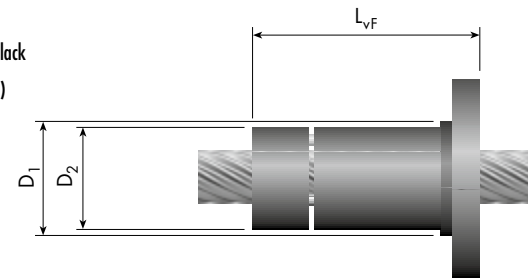

Torsion-preloaded, if $p_0 \geq d_0$:

SFT EX100 white

(bronze on request)

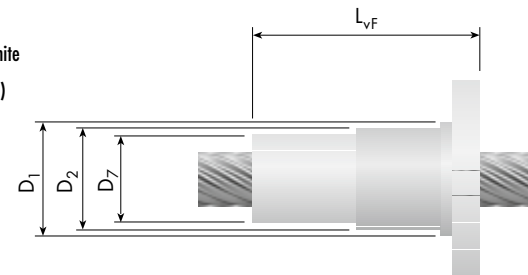

Nominal size d_0 / p_0 [mm] (in)	Right-hand/ left-hand thread	Dimensions [mm]															Load rates for POM-C/EX100 C_{stat} [N]	Nominal size d_0 / p_0 [mm] (in)
		Screw				Nut												
		d_1	d_2	p	g	$D_{1\text{H8}}$	$D_{2\pm0.05}$	$D_{4\text{TK}}$	D_5	D_6	D_7	L_{nF}	L_{nB}	L_{vF}	L_1	L_2		
26 / 16 ³⁾	RH / —	26.0	21.8	16	4	42	41.5	53	6.2	64	—	50	35	71	5	8	1 400	26 / 16 ³⁾
26 / 24	RH / —	26.0	22.3	24	6	42	41.5	53	6.2	64	—	50	35	71	5	8	2 000	26 / 24
26 / 60	RH / —	26.0	22.2	60	12	42	41.5	53	6.2	64	39	50	35	71	5	8	3 250	26 / 60
27 / 45 ³⁾	RH / —	27.0	22.5	45	9	42	41.5	53	6.2	64	39	50	35	71	5	8	2 550	27 / 45 ³⁾
28 / 65 ³⁾	RH / —	28.0	24.2	65	13	42	41.5	53	6.2	64	39	50	35	71	5	8	3 500	28 / 65 ³⁾
30 / 28	RH / —	30.0	26.5	28	7	42	41.5	53	6.2	64	—	50	35	71	5	8	2 000	30 / 28
30 / 50	RH / —	29.8	25.3	50	10	42	41.5	53	6.2	64	39	50	35	71	5	8	2 800	30 / 50
30 / 70	RH / —	30.0	26.2	70	14	42	41.5	53	6.2	64	39	50	35	71	5	8	3 750	30 / 70
32 / 20 ³⁾	RH / —	32.0	27.8	20	5	50	49.5	65	9.0	80	—	70	50	—	10	12	2 000	32 / 20 ³⁾
32 / 75 ³⁾	RH / —	32.0	28.2	75	15	50	49.5	65	9.0	80	—	70	50	—	10	12	4 000	32 / 75 ³⁾
32 / 96.5 (1¼"/3¼")	RH / LH	32.2	29.0	96.52	19	50	49.5	65	9.0	80	—	70	50	—	10	12	4 600	32 / 96.5 (1¼"/3¼")
34 / 32 ³⁾	RH / —	34.0	30.5	32	8	50	49.5	65	9.0	80	—	70	50	—	10	12	2 300	34 / 32 ³⁾
34 / 80	RH / —	34.0	30.2	80	16	50	49.5	65	9.0	80	—	70	50	—	10	12	4 250	34 / 80
36 / 200	RH / —	36.0	33.4	200	40	50	49.5	65	9.0	80	—	70	50	—	10	12	4 500	36 / 200

Nut types (details > page 41)



Legend

d_0 = Nominal screw diameter [mm]
 d_1 = outer screw diameter [mm]
 d_2 = core diameter [mm]

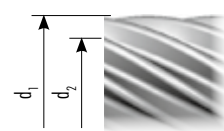

p_0 = nominal pitch [mm]
 p = effective pitch [mm]
 g = number of threads [—]

L_{nF} = length of nut body, non-preloaded, POM-C (type SFM)
 L_{nB} = length of nut body, non-preloaded, bronze (type SBM)
 L_{vF} = length of nut body, preloaded, POM-C/EX100 (types SFV and SFT)

C_{stat} = static load rates for non-preloaded and preloaded nuts made of POM-C / EX100 [N];
 for higher load rates → bronze nuts → $C_{stat\text{bronze}} = 1.3 \times C_{stat\text{POM-C/EX100}}$
³⁾ = only on request
 Special designs available on request

> CAD data > www.gewinde.ch



Design features

Eichenberger Easy light leadscrews set new benchmarks for net weight and smooth running properties. Thanks to the rolled aluminium screw and the associated nut made of high-performance technopolymer, the screw unit is a real lightweight. The screw's robust sliding coating (hard-anodised) makes the screw unit very smooth. With correct lubrication, efficiency of more than 0.8 can be achieved – an excellent figure for a leadscrew!

Thanks to the special thread geometry, the screw unit is also relatively impervious to dirt and tilting torque.

Materials

Screw

- standard:
 - aluminium, hard-anodised
- on request:
 - other materials and coatings

Nut

- standard:
 - EX100 white
- on request:
 - other materials

Nut type (shape)



Easy standard flange nut

Type EFM

- flange nut type A following DIN 69051
- not preloaded
- wear-resistant technopolymer EX100 white

If required, any application-specific nut shapes can be manufactured, for large series also from injection molding.

Contact us with your revolutionary idea – we'll provide YOUR tailor-made light leadscrew!

Operational temperatures

- EX100 –40 to +60 °C

Lead accuracy

- standard:
 - G9 $\hat{=}$ ≤ 0.1 mm/300 mm (in accordance with DIN 69051)
- on request:
 - other lead accuracies

Order system – Easy light leadscrews

Example for complete Easy light leadscrews _____	EGS 20×80 EFM RH 650 G9 E M
Type of thread drive _____ EGS = Easy light leadscrew	
Nominal size (d₀×p) [mm] _____	
Nut type _____ EFM = Easy standard flange nut (EX100 white) ¹⁾ MSX = special design according to drawing	for nut only
Right-hand / left-hand thread _____ RH = right-hand thread (standard) LH = left-hand thread (availability see dimensional chart)	
Leadscrew overall length [mm] _____ standard material quality: aluminium, hard-anodised ¹⁾	for screw only
Lead accuracy (class) _____ G9 = ≤ 0.1 mm/300 mm (standard) GX = lead accuracy upon specification	for screw only
Screw end machining _____ O = no end machining (cut by grinding) E = end machining according to drawing	for screw only
Assembly _____ G = screw and nut separate (standard) M = screw and nut assembled according to drawing/specified orientation	
¹⁾ other materials on request	
Example for screw only _____	EGS 20×80 RH 650 G9 O G
Example for nut only _____	EGS 20×80 EFM RH G

Efficiency

The efficiency η depends on the helix angle and reaches impressive values over 0.8
> also see diagram, page 44

Production / Handling / Lubrication

> see Speedy, page 42

Application examples for Eichenberger leadscrews

> see Speedy, page 43

Design fundamentals for leadscrews

> see Speedy, pages 44–45



ø 20

Standard flange nut

EFM

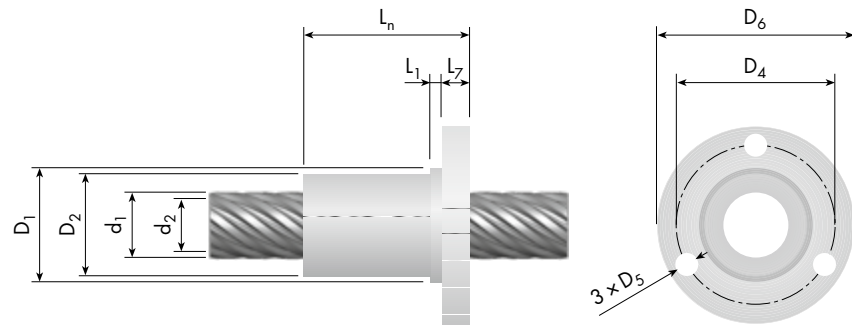

Nominal size $d_0 \times p$ [mm]	Right-hand/ left-hand thread	Dimensions [mm]											Load rates C_{stat} [N]	Nominal size $d_0 \times p$ [mm]
		Screw			Nut									
		d_1	d_2	g	$D_{1\ h8}$	$D_{2\ \pm 0.05}$	$D_{4\ TK}$	D_5	D_6	L_n	L_1	L_2		
20 x 80	RH / LH	20.0	15.2	8	36	35.5	47	6.2	59	46	5	8	4000	20 x 80

Nut type (details > page 58)



Flange nut, not preloaded
Type EFM

Legend

- d_0 = nominal screw diameter [mm]
- d_1 = outer screw diameter [mm]
- d_2 = core diameter [mm]

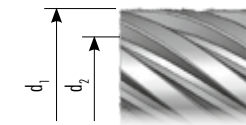

- p = pitch [mm]
- g = number of threads [-]
- Special designs available on request

Design fundamentals for leadscrews

> see Speedy, pages 44–45

> CAD data > www.gewinde.ch

Application examples

Thanks to their low weight, excellent smooth running properties and robust thread profile, Eichenberger Easy light leadscrews are suitable for numerous applications including:

- Drives for doors, gates and windows
- Handling technology
- Graphics equipment and devices
- Construction industry
- Air-conditioning technology (valve/slide drives)
- Textile machines
- Food and packaging industry
- Electric cylinders (actuators)
- etc.

Easy light leadscrews are preferred for increased demand from

- major temperature fluctuation based on climate,
- impact on environmental conditions such as pollution,
- limited lubrication options,
- tilting torque.

Eichenberger Easy light leadscrews always offer great value for money.



Easy door drives in train carriages of high speed trains withstand the harshest weather conditions and maximum physical forces

Rondo round-thread leadscrews (RGS)

100% Swiss made

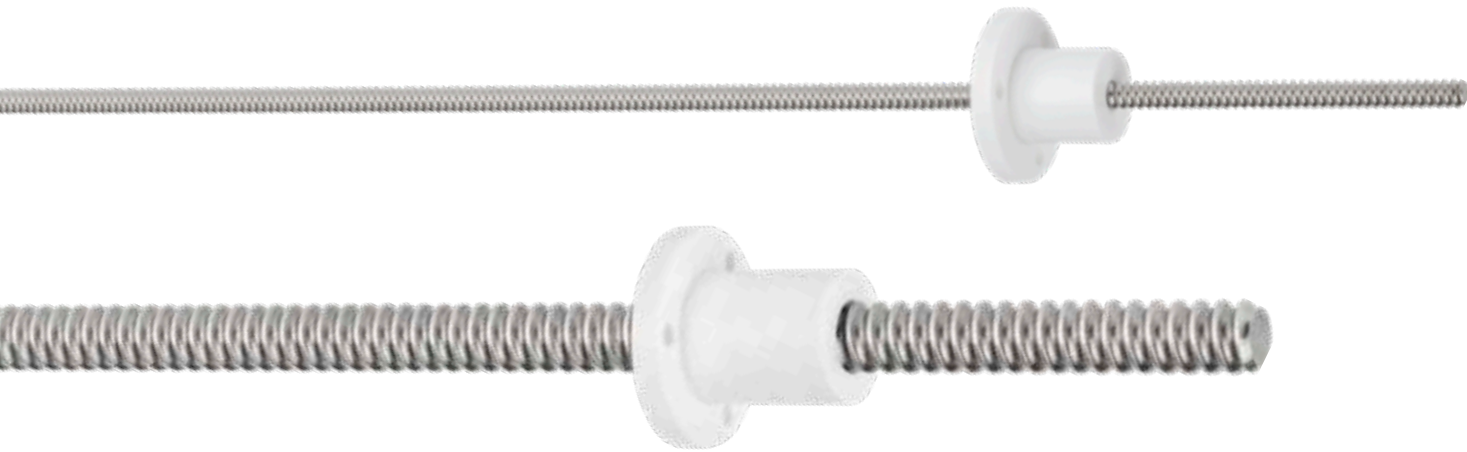

Design features

Eichenberger Rondo round-thread leadscrews are a true alternative to conventional trapezoidal screws. They deliver outstanding efficiency and quiet running due to their round-thread profile. Made of corrosion-protected steel or alternatively aluminium, the screws are combined with high-performance technopolymer flange nuts (outer dimensions equal those of Speedy standard flange nuts)

Materials

Screw

- standard: corrosion-protected steel
 - 1.4021 (X20Cr13)
- on request:
 - steel 1.0401 (C15)
 - aluminium
- on request:
 - coating to reduce sliding friction

Nut

- standard:
 - EX100 white
- on request:
 - iglidur® J *
 - other materials

Nut type (shape)



Rondo standard flange nut

Type RFM

- flange nut type A following DIN 69051
- not preloaded
- wear-resistant technopolymer EX100 white

If required, any application-specific nut shapes can be manufactured, for large series also from injection molding. Contact us with your revolutionary idea – we'll provide YOUR tailor-made round-thread leadscrew!

Operational temperatures

- EX100 -40 to +60 °C
- iglidur® J * -50 to +90 °C

Lead accuracy

- standard:
 - G9 $\hat{=}$ ≤ 0.1 mm/300 mm (in accordance with DIN 69051)
- on request:
 - other lead accuracies

* iglidur® is a registered trademark of igus® GmbH

Order system – Rondo round-thread leadscrews

Example for complete Rondo round-thread leadscrew	RGS 10x3 RFM RH 350 G9 E M
Type of thread drive RGS = Rondo round-thread leadscrew	
Nominal size (d ₀ xp) [mm]	
Nut type RFM = Rondo standard flange nut (EX100 white) ¹⁾ MSX = special design according to drawing	for nut only
Right-hand / left-hand thread RH = right-hand thread (standard) LH = left-hand thread (availability see dimensional chart)	
Leadscrew overall length [mm] standard quality: 1.4021 (X20Cr13) ¹⁾	for screw only
Lead accuracy (class) G9 = ≤ 0.1 mm/300 mm (standard) GX = lead accuracy upon specification	for screw only
Screw end machining O = no end machining (cut by grinding) E = end machining according to drawing	for screw only
Assembly G = screw and nut separate (standard) M = screw and nut assembled according to drawing/specified orientation	
¹⁾ other materials on request	
Example for screw only	RGS 10x3 RH 350 G9 O G
Example for nut only	RGS 10x3 RFM RH G

Efficiency

The efficiency η depends on the helix angle and reaches values from ~0.3 up to 0.5
> also see diagram, page 44

Production / Handling / Lubrication

> see Speedy, page 42

Application examples for Eichenberger leadscrews

> see Speedy, page 43

Design fundamentals for leadscrews

> see Speedy, pages 44–45



ø6...16

Standard flange nut

RFM

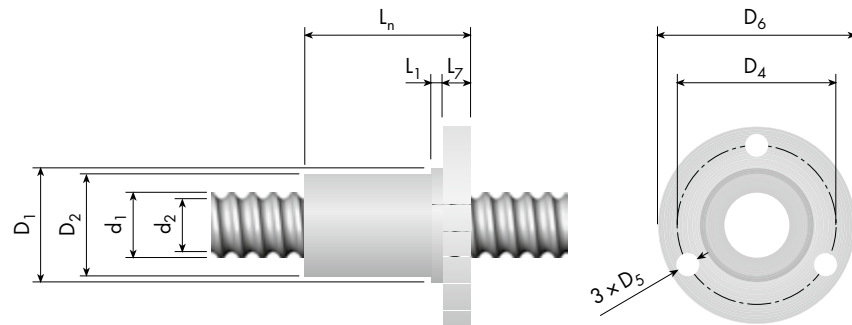

Nominal size $d_0 \times p$ [mm]	Right-hand/ left-hand thread	Dimensions [mm]										Load rates C_{stat} [N]	Nominal size $d_0 \times p$ [mm]
		Screw			Nut								
		d_1	d_2	D_1 h8	$D_2 \pm 0.05$	D_4 TK	D_5	D_6	L_n	L_1	L_2		
6 × 2	RH / LH ³⁾	5.9	4.5	21	20.5	29	4.2	38	25	3	5	600	6 × 2
8 × 2	RH / LH	7.9	6.5	21	20.5	29	4.2	38	25	3	5	800	8 × 2
10 × 3	RH / LH	9.9	7.8	24	23.5	32	4.2	42	25	3	5	1200	10 × 3
12 × 3	RH / LH ³⁾	12.0	9.9	26	25.5	36	5.1	46	42	3	7	2000	12 × 3
12 × 4	RH / LH ³⁾	12.0	9.8	26	25.5	36	5.1	46	42	3	7	2500	12 × 4
12 × 5	RH / —	12.3	9.4	26	25.5	36	5.1	46	42	3	7	2200	12 × 5
14 × 3	RH / LH ³⁾	14.0	12.0	26	25.5	36	5.1	46	42	3	7	2400	14 × 3
14 × 4	RH / LH	14.0	11.5	26	25.5	36	5.1	46	42	3	7	3200	14 × 4
16 × 4	RH / —	16.0	13.5	30	29.5	39	5.1	49	42	3	7	3900	16 × 4
16 × 5	RH / LH	15.7	13.0	30	29.5	39	5.1	49	42	3	7	5000	16 × 5

ø6...16

Nut type (details > page 62)



Flange nut, not preloaded
Type RFM

Legend

- d_0 = nominal screw diameter [mm]
- d_1 = outer screw diameter [mm]
- d_2 = core diameter [mm]
- p = pitch [mm]

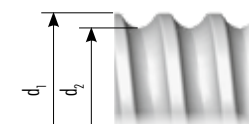

³⁾ = only on request

Special designs available on request

> CAD data > www.gewinde.ch

Design fundamentals for leadscrews
> see Speedy, pages 44–45

Thread rolling

Advantageous thread production for everyone

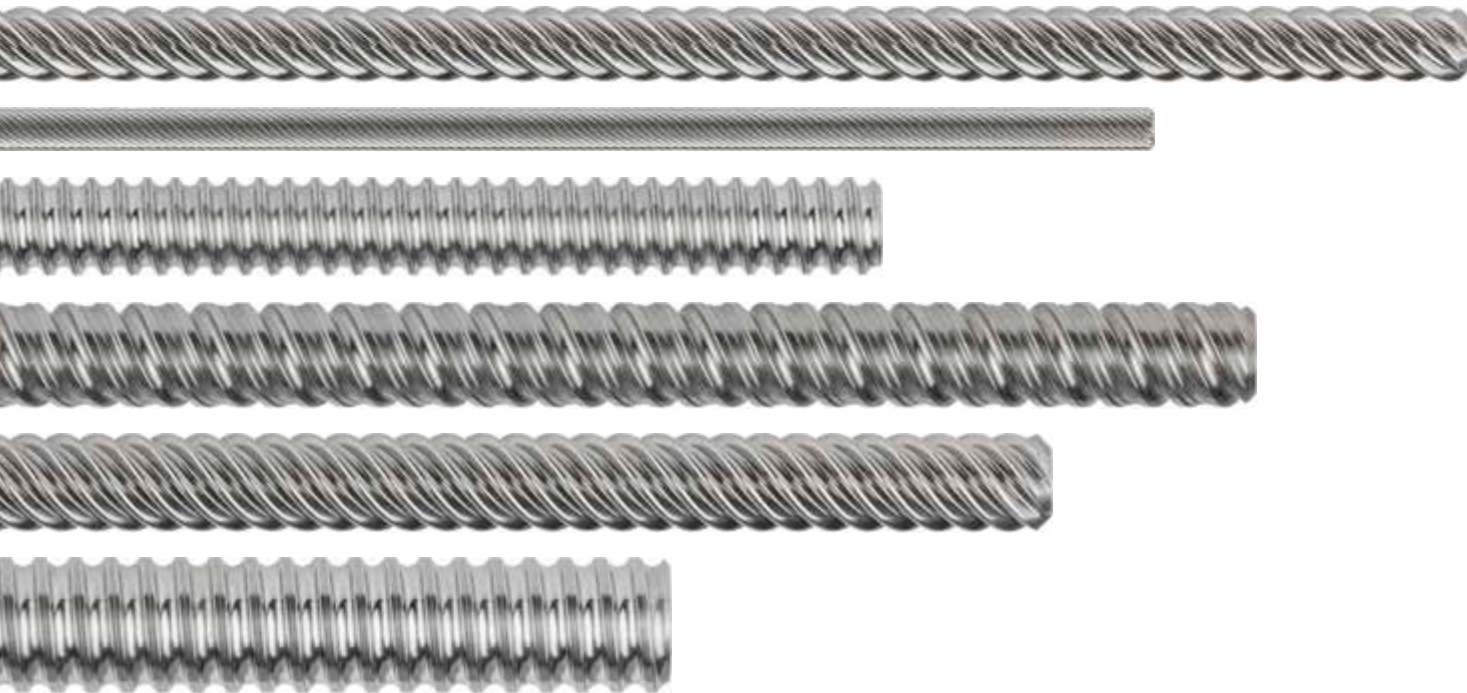

The core competency of Eichenberger Gewinde AG is thread rolling. Production companies can also benefit from this if they want to have any type of threads efficiently manufactured.

State-of-the-art production methods, extensive product expertise and access to more than 1000 machine tools, enable us to meet each and every demand for rolled threads – however exotic they may be:

- pitches up to 6 x diameter
- spindle length up to 6 m
- spindle diameter from 2 to 160 mm
- all standard profiles (M, Tr, UNC, UNF, UNEF, Whitworth)
- high-helix thread profiles
- ballscrew thread profiles
- special profiles
- multiple start threads including right-hand/left-hand threads
- worm gears (quality and price advantages)
- serrations and knurlings
- conical threads
- threads on prefabricated and/or irregular parts, e.g. also on forged parts



Suitable materials for thread rolling:

- high-alloy, corrosion and acid-resistant steel
- special aluminium alloys
- riveting-quality brass
- copper alloys

Threads can be rolled on hollow bodies and tubes only if wall thickness is sufficient; this wall thickness depends upon the type and depth of intended profile as well as material used. We are happy to provide advice.

We look forward to your challenge!

Eichenberger Gewinde AG



About us

The name Eichenberger Gewinde AG has stood for work in the area of thread production of the highest quality since 1953. With our innovative drive technology products as well as our comprehensive services as a supplier (thread production using cold-forming), we are supporting our customers with unique products and extensive know-how as a thread specialist and partner.

Development, production and IMS

“Quality first”: As a certified company, we leave nothing to chance, from development and manufacture to delivery. Our integrated management system complies with **ISO 9001** (Quality Management) and **ISO 14001** (Environmental Management). This guarantees a quality benchmark that makes us the preferred partner of many well-known companies all over the world.

A company of the Festo Group

Eichenberger Gewinde AG – together with its affiliate for the automotive industry, Eichenberger Motion AG – has been a company of the globally active Festo Group since 2016.



History

- 1953 Founding of precision turning workshop Hans Eichenberger
- 1986 Change of name to Eichenberger Gewinde AG
- 1988 Start of in-house ballscrew development
- 1995 Introduction of automated manufacture
- 1998 Take-over of Eichenberger Gewinde AG by the management
- 2004 Founding of Eichenberger Motion AG (large-scale production for the automotive industry)
- 2006 Production site expansion; doubling the production space
- 2016 Integration into Festo Group
- 2018 With 150 employees, we are supplying about 900 customers in 45 countries all over the world – with an export share of 80%





Eichenberger Gewinde



Map and directions

› www.gewinde.ch

Eichenberger Gewinde AG

Grenzstrasse 30

5736 Burg

Switzerland

Phone +41 62 765 10 10

Fax +41 62 765 10 55

info@gewinde.ch

The contents of this publication is protected by copyright held by the publisher and may not be reproduced (even in part) unless permission is granted. Every care has been taken to ensure the accuracy of the information contained herein but no liability shall be accepted for any loss or damage whether direct, indirect or consequential resulting from or in connection with the use of the information contained herein. This catalogue supersedes previous catalogues in which the data deviate from those contained herein. Data subject to change as required by technological developments.

© Eichenberger Gewinde AG

Edition: V 18 07 18 e